

dynaco **QSA 300**

This number must be mentioned in all communications concerning this equipment.

INSTRUCTIONS FOR ASSEMBLY OPERATION



dynaco inc.

COLES ROAD & CAMDEN AVENUE / POST OFFICE BOX 88
BLACKWOOD, N. J. 08012, U.S.A.

CONTENTS

Specifications	2	Circuit Description	14
Introduction	3	Block Diagram	14
Installation	3	Combining Channels	19
Connections	3	Meter Operation	20
Operation	4	240 Volts Wiring	20
Assembly Instructions	5	In Case of Difficulty	20
Mechanical Assembly	6	Voltages	22
Wiring the Heat Sink		Circuit Board Layouts	22
and PC-43	9	Service Policy and Limited Warranty	23
Wiring the Chassis	15	Kit Parts List	24
Final Assembly	16		
Schematic Diagram	12	Pictorial Diagram	Insert
Component Values	13	MC-3 Meter Assembly Instructions..	Insert

SPECIFICATIONS

Rated 4-channel power output:

75 watts continuous average power per channel into 8 ohms (40 watts per channel into 16 ohms), 20 Hz-20 kHz, at less than 0.25% total harmonic distortion. Distortion reduces at lower levels. For optional conversion to 2-channel use, see available output power listed below.

Available 4-channel power output:

(See above for F.T.C. Power Ratings)

20 Hz to 20 kHz, all channels driven:

- 75 watts continuous average per channel @ 8 ohms;
- 100 watts continuous average per channel @ 4 ohms;*
- 40 watts continuous average per channel @ 16 ohms.

Available 2-channel power output (optional):

Low impedance mode connections:

- 80 watts continuous average per channel @ 8 ohms;
- 150 watts continuous average per channel @ 4 ohms;
- 200 watts continuous average per channel @ 2 ohms.*

High impedance mode connections:

- 80 watts continuous average per channel @ 16 ohms;
 - 150 watts continuous average per channel @ 8 ohms.*
- * 5 minutes sustained full power limit without a fan.

Power at clipping, single channel, 2500 Hz, less than 1% distortion:

- 90 watts @ 8 ohms.
- 130 watts @ 4 ohms.
- 45 watts @ 16 ohms.

Power at clipping, 2-channel mode, 2500 Hz, less than 1% distortion:

- Low-Z mode: 95 watts @ 8 ohms; 160 watts @ 4 ohms;
- 240 watts @ 2 ohms.

High-Z mode: 90 watts @ 16 ohms; 160 watts @ 8 ohms.

Intermodulation distortion:

Less than 0.25% at any power level up to 75 watts rms per channel into 8 ohms with any combination of test frequencies. Distortion reduces at lower power levels.

Half-power bandwidth:

37.5 watts per channel at less than 0.25% total harmonic distortion from 5 Hz to 50 kHz into 8 ohms.

Frequency response:

- +0, -1 dB, 10 Hz-40 kHz @ 1 watt into 8 ohms
- ±0.5 dB, 20 Hz-20 kHz @ 75 watts into 8 ohms

Hum and noise:

Greater than 95 dB below rated output, full spectrum.

Input:

35,000 ohm load; 1.0 volt for 75 watts @ 8 ohms.

Slewing rate:

7 volts per microsecond.

Damping factor:

- Greater than 80 to 1 kHz into 8 ohms.
- Greater than 50 to 10 kHz into 8 ohms.

Channel separation:

Greater than 70 dB by IHF standards.

Connectors:

Inputs: phono jacks. Outputs: color coded 3-way binding posts with standard 3/4" spacing.

Dimensions:

18 3/8" wide, 14 3/8" deep, 7 3/8" high.

Weight:

Shipping weight: 58 lbs. Net weight: 52 lbs.

Power consumption:

120 v.a. quiescent; 10 amps maximum; 50/60 Hz, 120/240 vAC.

INTRODUCTION

The Dynaco QSA-300 is a basic four channel power amplifier employing all silicon semiconductors. They include 52 transistors, and 40 diodes. The output circuitry is of the fully complementary symmetry design. The entire amplifier, except for an input network, is direct coupled. Its measured distortion levels approach the threshold of the most exacting laboratory test equipment, not only at the commonly specified full power ratings, but more importantly at very low power outputs as well. This is the result of circuit techniques which eliminate any discernible crossover notch at low levels, and contributes to the QSA-300's freedom from listening fatigue. Its accurate, uncolored sonics have been achieved on a wide variety of loudspeaker loads, including electrostatics and multiple drivers with complex crossovers.

The design of a superb power amplifier implies the neces-

sity of several protection techniques for the amplifier, and for the speaker load. In addition to the AC line fuse, eight separate B+ fuses are supplied. Electronic volt-amp limiting ensures safe operation of the output transistors, and two thermal breakers are mounted directly on the heat sink. An unusually large radiating area for the heat fins, which are coupled to an aluminum back panel, forms highly efficient heat sink. Speaker fuses protect the load.

The QSA-300 has been designed as four independent 75 watts (at 8 ohms) amplifying channels with two independent power supplies each having a high degree of inherent regulation. In addition, where either higher powers or higher volt-amp capabilities are required for lower load impedances, internal restrapping permits stereophonic operation.

INSTALLATION

The QSA-300 should be located where the front panel power switch is convenient, since many control preamplifiers do not normally include the requisite heavy duty switching. Dynaco's PAT-5 is a notable exception, however. If the amplifier is to be mounted near a phonograph, check to make sure that the phono cartridge does not pick up hum from the power transformers in the amplifier. In addition to the finned heat sink, it is normal for the top to get rather warm when delivering high power output.

VENTILATION is an important consideration. Although solid state units do not generate the high heat expected from tube designs, they can be limited by excessive heat buildup. All solid state amplifiers generate very nearly the same heat at 10% as they do at 100% power output, and maximum heat is generated at about 40% of full power. Thus, ADEQUATE AIR CIRCULATION IS ESSENTIAL. The QSA-300 puts

out the heat of a 75 watt lamp under quiescent (no signal) conditions, and several hundred watts of heat at high power levels. The large heat sink has more than enough cooling capacity for any music or speech signals—even at very high powers—if fresh air flow under and around the unit is not restricted.

The QSA-300 is intended to be installed horizontally, with its feet providing clearance for air flow under the unit. Do not allow the ventilation slots in the bottom to be restricted (don't place the amplifier on a rug, for example). The amplifier should not be mounted vertically, unless it is fan-cooled, and DO NOT TRY TO SUPPORT THE UNIT BY THE FRONT PANEL.

If you wish to mount the amplifier through a cabinet panel, a cutout $6\frac{3}{4}'' \times 17\frac{3}{8}''$ is suggested. Remove the feet for front mounting access. A support flush with the bottom of the cutout should include an opening for the chassis vents.

CONNECTIONS

INPUT

Signal inputs are connected by shielded cables to conventional phono jacks on the rear panel, under the heat sink. The amplifier's nominal input load impedance is 35,000 ohms. The input sensitivity is 1.0 volt for full output. The QSA-300 may thus be easily driven by control preamplifiers such as the Dynaco PAT-5, PAT-4 or PAS-3X. The Dynaco PAS-3X tube type preamplifier requires an internal modification. To change, simply locate and remove the pair of 62,000 ohm resistors (blue-red-orange) on the PC-5 printed circuit board in the preamp. Earlier PAS-2 and PAS-3 preamplifiers cannot be modified for use with the QSA-300. Some other tube type preamplifier brands may require modification for optimum performance into a 35 K ohms load.

It is desirable to keep the input cables close together throughout their run to avoid extraneous hum.

OUTPUT

Select speaker leads of sufficient size to preserve the high damping factor of your amplifier. Standard 18 gauge lamp cord ("zipcord") is suitable for distances up to 30 feet with an 8 ohm load. A larger wire size is advised for longer distances—#16 for 50 feet; #14 for 80 feet. #18 and #16 lamp

cord is available from hardware and electrical supply stores, and is the easiest to use and conceal. For a 4 ohm load, these maximum distances should be cut in half, if you wish to maintain high speaker damping.

If you are using a quadrasonic system, it is advisable to use the two outside (A & D) channels for the front, and the two inside (B & C) channels for the back. When driving two separate stereo systems, use channels A & B for one system and channels C & D for the other to achieve maximum isolation. Be sure to maintain similar wiring "sense" for each speaker, so that they will be connected *in phase*. Normally the (—), common, or ground terminal of each speaker is connected to the black amplifier terminal. Proper phase sense is easily maintained with lamp cord because one conductor is coded with a molded ridge on the outer insulation.

Two speakers are connected in phase when maximum low frequency output is heard when they are driven from a monophonic source. Lowered output is observed when the connection to one of the speakers is reversed (out of phase, or reversed polarity). When using multiple speakers on each channel, or when 4-channel systems are used, it is important that all of the speakers in the same area be wired in phase.

The amplifier terminals are 3-way binding posts which will accept single or double "banana plugs", spade lugs, or simply stranded wire. If stranded lamp cord is used, the wire ends should be "tinned" with solder first to avoid fraying. To connect the wire, unscrew the terminal cap until the horizontal hole through the metal shaft is uncovered, push the wire end through the hole, and tighten the cap.

Make certain that no wire strands can touch other than the intended terminal. Double banana plugs (from radio supply houses) are the most convenient connectors, and are simply inserted into the ends of the terminals. They are particularly useful if a second set of speakers is to be connected in parallel, as they plug into one another.

The black "common" output terminals are electrically connected internally. They are also connected to the chassis, so the QSA-300 may be used with special output connections which require common grounds. You must be *certain* that the polarity of such output connections is never reversed,

however, so that the red "hot" terminals can never be connected together in other equipment.

AC POWER

The power cord should be plugged into a wall outlet providing 120 volts, 50/60 Hz on a 15 ampere (minimum) circuit. Do not attempt to switch the amplifier remotely by plugging it into a switched outlet on a control preamplifier unless the outlet is designated as a 10 amp (1,200 watts) or higher capacity. *Most preamps are normally not designed to handle the high current switching.* The Dynaco PAT-5 is an exception.

Each pair of channels—A and B; C and D—is protected by a thermal breaker. If the breaker for channels A and B opens, these channels will shut down. Channels C and D will remain on. If the breaker for channels C and D opens, these channels will shut down *together with the power lamps.* Channels A and B will remain on.

OPERATION

Almost silent turn-on and turn-off transients are a result of nearly equal charge (or drain) of the plus and minus supply voltages. However, harmless low frequency movement of the speaker may be observed as the voltages stabilize at turn-on, and decay at turn-off.

The QSA-300 includes circuits to protect against the hazards of short circuit outputs, and abnormal load demands. Good operating practice will avoid the need to test their effectiveness, however, for there is no such thing as absolute protection from abuse.

The combination of moderately high power potential and the relative fragility of most high quality speakers makes it imperative that you take care to avoid such common faults as dropping a stylus (tone arm) onto a record; allowing the arm to skid across the record; or flicking the stylus with your finger while the volume is up on the preamplifier. These are typical errors which generate heavy low frequency pluses capable of severely overdriving the amplifier and consequently the speaker at subsonic frequencies.

LOUDSPEAKER RATINGS

Nominal speaker power ratings are a matter of concern. There is currently no U.S. standard. Manufacturers usually provide a "music power" rating, or indicate amplifier power limits. These should not be confused with continuous, or "rms" power acceptance for a sustained period which will be substantially lower. It is rare for a speaker to be able to handle as much power near the frequency extremes as in the midrange. Single woofer high fidelity speaker systems rarely have "music" ratings as high as 100 watts, or continuous duty wide band sine wave ratings as high as 40 watts.

In view of the power limitations of most high accuracy speaker systems, the connection of two or four similar speakers in the same location to a single channel is often advisable if high signal levels are wanted. Lacking more definitive advice, a rough test is to place your hand in front of the woofer when playing a loud passage at your anticipated listening level. If you can feel *any* heat generated by the voice coil, you should consider the need for additional speakers to reproduce that level safely. When high output, high accuracy reproduction is desired, a series-parallel con-

nection of four 8 ohm speakers (such as the Dynaco A-35) on each channel provides a resultant 8 ohm load with exceptional power handling capacity.

Speaker impedances varies with frequency—often by a factor of 4 or 5 to 1. Even the least variable speakers, like Dynaco's, have a 2:1 change. While most nominal ratings are close to the actual minimum impedance, when combinations approach the 4 ohm minimum recommended amplifier load, the safest procedure is to measure the resistance across the terminals with an ohmmeter. Speaker impedance usually varies upwards from this value. Use this figure to determine how multiple speakers (on each channel) should be connected:

IN PARALLEL:	IN SERIES:	IN SERIES-PARALLEL:
2× 8 ohms=4 ohms	2×4 ohms= 8 ohms	4×16 ohms=16 ohms
2×16 ohms=8 ohms	2×8 ohms=16 ohms	4× 8 ohms= 8 ohms
4×16 ohms=4 ohms	4×4 ohms=16 ohms	4× 4 ohms= 4 ohms

These simple examples assume identical models. It is not wise to connect dissimilar speakers in series or in series-parallel because of adverse audio effects.

LOUDSPEAKER FUSING

The outputs of the QSA-300 are provided with speaker fuses. The 3 ampere, 3 AG, fuses supplied will not fail when the amplifier is operated at full power (75 watts into 8 ohms), and therefore they provide **NO PROTECTION** for your speakers. Please understand that a fuse in series with the output of an amplifier is supplied primarily as protection for the speaker, although it does provide a measure of protection for the amplifier circuits. Nevertheless, the size of the fuse should be determined by the type of speaker you are using.

Since the power passed by a fuse varies with load impedance, and test signals have little correlation to music signals, and fuses vary in their tolerance of music overloads, the protective rating determination for a speaker is largely empirical. Logic should suggest the smallest value fuse which does not blow frequently at what are high, but nonetheless safe levels for your speaker. There are few speakers capable of safely handling more power than will blow a 2 ampere fuse.

The speaker manufacturer who specifies a fuse rating solves your problem. Lacking this, remember that a fuse will not blow until a *sustained* signal *well above* its rating is imposed for a time. A slo-blo fuse will allow appreciably more overdrive than the same value standard fast-blow type, and is thus not generally recommended for speaker protection.

The chart at right shows the highest *sustained power* level which will *not* blow the fuses shown. Remember that speaker impedance typically rises well above its nominal value. Experience suggests that on this basis power levels of 10

watts are safe starting points for most high fidelity speakers using a single woofer.

3AG FUSE TYPE	4 OHMS	8 OHMS	16 OHMS
1/2 ampere	1 watt	2 watts	4 watts
3/4 ampere	2.2 watts	4.5 watts	9 watts
1 ampere*	4 watts	8 watts	16 watts
1 1/2 ampere**	9 watts	18 watts	36 watts

* Dynaco A-10, A-25 and A-35 speakers
 ** Dynaco A-25XL, A-40XL and A-50 speakers

ASSEMBLY INSTRUCTIONS

GENERAL ASSEMBLY INFORMATION

Construction of the QSA-300 is relatively easy when compared to other kits. The printed circuit boards for audio have been preassembled and tested to save you much of the work, and the assembly that remains is in an open, uncluttered layout to make wiring quick and easy. The construction time will be several hours. It is better to work slowly and carefully rather than concern yourself about the time.

When you unpack the kit, check off the components against the parts list on page 24. Separate the hardware items in an egg carton or similar container. You can identify unfamiliar parts by checking them against the Pictorial Diagram, bearing in mind that the drawing is necessarily somewhat distorted for visual separation.

Have the proper tools at hand before starting construction. The tools necessary are:

1. A pencil-type soldering iron with a 1/16" tip or smaller of 40 to 60 watts rating, with a tip temperature of 700 to 800° F.
2. A damp sponge or cloth to wipe the tip of the iron.
3. 60/40 rosin core solder not larger than 1/16" diameter.
4. A medium sized screwdriver (1/4" blade).
5. A #2 Phillips screwdriver (medium sized, cross-pointed tip).
6. Long nosed and diagonal cutting pliers.
7. Heavy "slip joint" pliers.
8. A single edged razor blade or inexpensive wire stripping tool for removing insulation.
9. Wood toothpicks.
10. Transparent or masking tape.

We do *not* recommend using a soldering gun. Not only can a gun provide more heat than is necessary—an unskilled user might damage printed circuit boards—but also many users tend to make poor solder connections, simply because they do not wait long enough for the gun to reach its operating temperature each time. Use a conventional pencil type iron.

A good solder connection does not require a large amount of solder around the joint. A well-made connection looks smooth and shiny because the solder *flows into the joint* when both parts are hot enough.

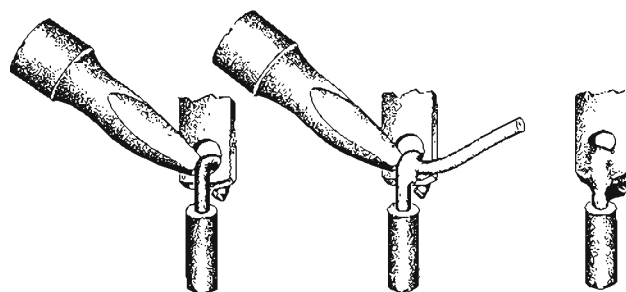
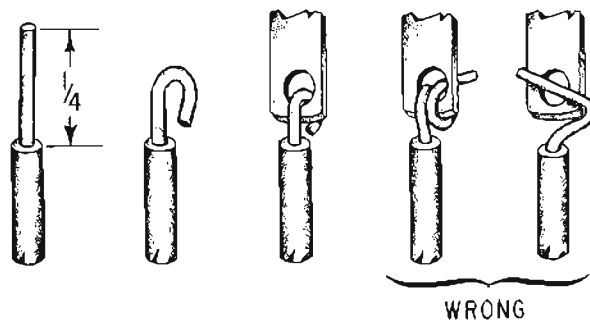

There are four steps to making a good solder connection:

1. Make a good mechanical connection.
2. Heat *both* parts with the tip of the iron *at the junction*.
3. Apply solder to the *junction* until it melts and flows.
4. Allow the connection to cool undisturbed.

ALL SOLDERING MUST BE DONE WITH A GOOD GRADE OF ROSIN CORE SOLDER.

Under no circumstances should acid core solder be used. Unmarked solder, cheap solder or any of doubtful origin should be discarded, and *separate solder fluxes should never be used*. The warranty is voided on any equipment in which acid core solder or acid type fluxes have been used. Silver solder is not suitable. The recommended solder is 60/40 (60% tin, 40% lead) ROSIN CORE. Do not confuse this with 40/60, which is harder to use.

You should realize that many of the more delicate components are less likely to be damaged in the soldering process if you use a hot iron for a short time, rather than a cooler iron for a longer period. You will also make a better connection with the hot iron. If you keep the iron clean by wiping the tip frequently, and occasionally add a small amount of solder to the tip, it will aid the transfer of heat to the connection. Do not allow too much solder to build up on the tip though, or it may fall onto adjacent circuitry.

One of the best ways to make a good mechanical connection is to bend a small hook in the end of the wire, and then to crimp the hook onto the terminal lug. The amount of bare wire exposed need not be exactly $\frac{1}{4}$ -inch, but if it is too long, the excess might touch another terminal lug or the chassis. Do not wrap the wire around the lug more than one time, as this makes the connection difficult to remove if an error is made.

Many of the wiring steps will call for "preparing" a wire of a certain length and color. This involves cutting the necessary length of wire and stripping $\frac{1}{4}$ inch of insulation from each end. This is most easily done with wirestrippers, but diagonal cutters can be used if you are careful not to nick the wire and weaken it.

When soldering a lead to a numbered, plated-through hole on a circuit board, push the lead through the hole first. *Do not push the wire all the way into the hole up to the insulation.* Apply the solder and the hot iron at the same time to the junction of the hole and lead. The solder should melt very quickly; it should flow easily and fully into the hole and completely around the lead. Remove the iron and allow the connection to cool. If in doubt of your connection, you may also wish to apply solder and iron to the hole and lead from the other side of the board. It is *essential* to have a smooth, shiny flow of solder from the lead to the plated circuitry on the board.

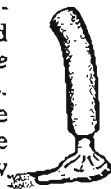

WIRING THE KIT

The position of all wire leads should follow the diagram closely, bearing in mind that the pictorial diagram has necessarily been distorted somewhat to show all connections clearly. See that uninsulated wires do not touch each other unless, of course, they are connected to the same point. It is especially important that uninsulated wires or component leads or terminals do not touch the chassis accidentally.

Whenever one wire is to be soldered to a connection such as a lug terminal or hole, the instructions will indicate this by the symbol (S). If more than one wire is to be soldered to the same point, the instructions will cite the number of wires that should be connected to that point when it is to be soldered. If no soldering instruction is specifically given, do not solder; other connections will be made to that point before soldering is called for.

MECHANICAL ASSEMBLY

This assembly comprises two identical stereo power amplifiers in one package, except for the Line Cord, the Power Fuse Block, and the Terminal Strip T-4 on the chassis, and the Power Switch and the Lamp Sockets on the front panel. Each half has been identified **RIGHT** or **LEFT** on the Pictorial Diagram. Most parts are mounted symmetrically from an imaginary centerline running front to back, which is shown as a dotted line on the Pictorial Diagram.

Select the painted back panel. Note that the outside surface is printed with white lettering. Some of the parts will be mounted from the outside, and others from the inside.

- 1() Select the two dual input socket strips, the matching two insulator strips, four small flat black washers, and four each #4 (smallest) screws and **KEP** nuts.

Check your work after each step, and make sure the entire step has been completed. When you are satisfied that it has been correctly done, check the space provided and go on to the next step. Be sure you read carefully the explanatory paragraphs in the assembly instructions.

Each PC-43 printed circuit board, which include most of the electronic components for the QSA-300, have been in-circuit tested before being packed into the kit. These tests include every significant performance criterion—gain, power, distortion, frequency response, functioning of protective circuitry—as well as provide precise adjustment of necessary circuit parameters to assure that your amplifier will meet or exceed the specifications when these instructions are adhered to, and all connections have been properly completed.

Where stranded wire is used, as on the transformer leads, be very careful not to cut through the strands when stripping the end. Where stranded wire is supplied for hookup wire in the kit, the strands will be bonded together to minimize this likelihood and make handling easier.

All mounting screws are installed from the *outside* of the chassis, and a nut with lockwasher attached, called a **KEP** nut, is used except when otherwise specified.

This kit uses a variety of hardware. Before starting assembly, separate all the hardware by using an egg carton, muffin pan, or small cups. #4, #6, #10 and $\frac{1}{4}$ " machine screws with oval (binder) heads are used in various lengths, but much of the hardware used is #6 binder head in a $\frac{1}{2}$ " length. There are also #6 *flat* head screws, which are used only when called for on the front panel. Two types of sheet metal screws are used—one kind in black with a cross-slotted (Phillips) head, and the second kind in bright metal with a coarse thread and a slightly tapered, blunt end.

The center "C" (collector) lugs of the sockets for the output transistors have a notch rather than a hole for mechanical connection. Crimp the wire in a tight "U" in the notch to hold it securely for soldering. In such cases, it may be helpful to strip *slightly* more than the standard $\frac{1}{4}$ " of insulation from the wire. Note that the mechanical crimping of the wire serves *only* to hold the wire stationary while the solder is applied. The integrity of every solder connection is essential.

Transistor equipment will not tolerate wiring errors, sloppy or incomplete soldering. **TAKE THE TIME TO BE NEAT AND ACCURATE**, and your amplifier will operate properly at first, and for many years.

These strips mount *inside* the two rectangular openings at the bottom of the back panel. Insert the screws from the outside, install an insulator first on the inside, then a flat washer on each screw, followed by an input strip, and fasten with the **KEP** nuts. The strip mounts in either direction. Make sure that the metal of the socket strip does not touch any surface of the back panel, and firmly tighten the hardware.

- 2() Select the four round speaker fuse holders, and install them from the outside. Their hardware is attached. The rubber washer stays outside the panel, and the flat side of the mounting hole engages a similar flat on the holder for proper positioning. Secure each holder with its lockwasher and nut.

- 3() Install the four *black* binding posts in the holes next to the input sockets at the *bottom* of the panel. Their hardware is attached. See the sketch below. The shoulder piece goes on the outside of the back panel with the smaller diameter portion protruding through the hole. The insulating plastic ring fits over it inside the back panel, followed by the washer. Before tightening the first nut, unscrew the outside knurled end and observe the hole in the metal shaft. For greater convenience in connecting leads to these posts later, rotate the assembly so that this hole is in a horizontal position. Slip a short piece of wire through the hole for easy observation as you firmly tighten the first nut. Slide on the connecting lug, and fasten with the second nut. Position each connecting lug as shown in the Pictorial Diagram, and keep the hole horizontal as you firmly tighten the second nut.

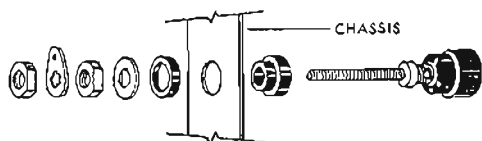

- 4() In a similar manner, install the four *red* binding posts in the holes above the black posts. Keep the hole in the metal shaft horizontal, and note the correct lug placement in the Pictorial Diagram.
- 5() Select the two round thermal sensors with an attached screw, and two #6 (next to the smallest size) $\kappa\epsilon\pi$ nuts. Each sensor mounts in a hole at the *top* of the panel directly above the input sockets. Insert the screw from the *inside*, position the solder lugs parallel to the top of the back panel, and fasten securely with a nut on the *outside*. Note that these are the only nuts fastened from the outside.

Much of the hardware used to mount the parts in this kit is #6-32 x $\frac{1}{2}$ ". If no mention is made of the type of hardware, use this size. A set is one screw and one $\kappa\epsilon\pi$ nut.

- 6() Select one of the black heat fins, a long 6-lug terminal strip, and six sets of #6 hardware. We recommend that you now install masking or transparent tape around the outer edges of the black heat fins to protect their finish and your work surface. The back panel has four groupings of holes, and the central portion of the heat fin has matching holes. Place the flat of the heat fin against the *outside* of the back panel so that all the holes match. If a "T" is stamped in the heat fin, this indicates the top. Insert the screws from the *outside* in the six *smaller* holes. Then mount the terminal strip on the inside, positioned as shown in the Pictorial Diagram. Fasten with a $\kappa\epsilon\pi$ nut on all six screws, and tighten only the two center screws very tightly. The other four screws should remain finger tight until later.
- 7() Select the remaining three black heat fins, three more long 6-lug terminal strips, and 18 sets of #6 hardware. In a similar manner, tape the outer edges of the heat fins, and place them on the back panel. Match the remaining groups of holes in the back panel with those of the heat fins, mount a 6-lug terminal strip on the inside and firmly tighten only the two center screws on each heat fin.

Set this assembly aside, and place the front panel in front of you. Note that the edges of the inside surface are turned up. The few parts mounted on this panel will be mounted on the inside.

- 8() Select the power switch, two #6 screws with *flat heads*, and two lockwashers. Note that each lockwasher is deliberately supplied one size larger than the screw, to provide greater thickness. Insert the screws from the outside in the countersunk holes provided, place the lockwashers over the screws on the inside, and install the power switch so that its solder lugs are nearest the *center* of the panel. Nuts are not required, as the switch has tapped mountings.
- 9() Select the two lamp sockets, two #6 screws with *flat heads*, two lockwashers, and two #6 $\kappa\epsilon\pi$ nuts. Insert the screws from the outside in the two countersunk holes *above* the small cutout on the other end of the panel, place the lockwashers over the screws on the inside, install each socket, and fasten with a nut on each screw. Position the sockets at an angle, as shown in the Pictorial Diagram (so that the lamps, when installed, will appear in the center of the rectangular opening), and tighten the screws firmly. [If the MC-3 meter kit has been obtained, skip this step. The lamp sockets are not used.]

This completes the mechanical assembly of the front panel. Set this assembly aside, and place the main chassis bottom plate in front of you, flanges down.

- 10() Select the four rubber feet, and the four $\frac{1}{4}$ " diameter bolts (the largest hardware). Insert a screw through each foot, and then mount a foot at each corner of the chassis on the *outside* (flanges down). No other hardware is required; the chassis is supplied with threaded nuts for these screws.

Turn the chassis over, flanges up, with the four *pairs* of adjacent parallel slots at the back toward you.

- 11() Select the power (single clip) fuse block, and a #4 screw and $\kappa\epsilon\pi$ nut (smallest hardware). Insert the screw from the outside, and install the fuse block in the smallest hole at the front center of the chassis. See that the block is parallel to the front of the chassis, and in front of the two nearby chassis "dimples". Tighten the hardware.
- 12() Select the two B+ (four clip) fuse blocks, and the remaining four sets of #4 hardware. If the chassis has two slots $3\frac{1}{2}$ " (9 cm) from the back edge, install the fuse blocks over the slots and use the ends of the slots and the outer holes in the fuse blocks for the hardware. If the chassis has four small holes $3\frac{1}{2}$ " (9 cm) from the back edge, install the fuse blocks over the small holes. Insert the screws from outside, and tighten the hardware.
- 13() Select the remaining long 6-lug terminal strip, and two sets of #6 hardware. Install the strip in front of the power fuse block, as shown in the Pictorial Diagram. Tighten the hardware.
- 14() Select the two 1" square diode blocks, two $\frac{3}{4}$ " #6 screws, and two #6 $\kappa\epsilon\pi$ nuts. Note that the terminals of each block are identified "+", "-", and (two) "AC". Each block will be mounted back of a front rubber foot. The "+" terminal (which may be identified by a red dot or a very small locating lug on

the flat surface) lies over a tiny hole in the chassis. *Make certain these diode blocks are correctly positioned.* Install each block over the screw through the chassis, and secure it with a nut. Recheck the location of the "+" terminal and tighten the hardware securely.

- 15() Select one of the large 10,000 μf capacitors, one of the large circular capacitor mounting brackets, one of the short 6-lug terminal strips, and five sets of #6 hardware. *Do not remove the clear plastic outer insulation from any of these capacitors.* This bracket will be installed to the right of the right B+ fuse block. Note in the Pictorial Diagram the correct position of the clamp, and also the direction of the clamping screw. One set of #6 hardware is first installed in the clamp before mounting. Insert the capacitor in the bracket, position the "+" on top to the back as shown, and temporarily tighten the clamp. Now mount the bracketed capacitor with the remaining hardware. One end of the 6-lug strip is mounted on the front screw before the KEF nut is installed, and the other end of the strip over the remaining hole on the right, as shown in the Pictorial Diagram. Now securely tighten the clamping screw on the capacitor bracket. Finally securely tighten the capacitor bracket and the 6-lug strip to the chassis.
- 16() Select the other three large capacitors, the remaining three brackets, the last short 6-lug terminal strip, two of the solder lugs, and 13 sets of #6 hardware. Slide each capacitor into a bracket as before with the clamping screw attached, and mount each capacitor as shown in the Pictorial Diagram. Position the "+" as shown, and tighten the clamp first. The solder lug for each of the two center capacitors is mounted *first* over each back screw, between the chassis and the bracket; one end of the other 6-lug strip is mounted on the front screw of the left capacitor bracket, and the other end over the hole back of the nearby diode block. Position the solder lugs as shown, and secure the capacitor brackets and the 6-lug strip to the chassis. See that the hardware for the two solder lugs is very tight.
- 17() Select the eight $\frac{3}{8}$ " #10 SEMS screws (with lock-washers attached), and the remaining eight solder lugs. Install the solder lugs on capacitor terminals C1 lugs #1 and #2, and on C2 lugs #3 and #4 for *both* the right and left sides. Position the lugs as shown in the Pictorial Diagram, and secure each with a screw. See that the screws are very tight.
- 18() Select the front panel assembly, and two #6 black Phillips head *sheet metal* screws. Place the front panel in position inside the flanges of the chassis. Insert a screw in the corner hole of the flange at each end. The screws cut their own thread and therefore some force is required. Use a #2 Phillips screwdriver, but do not tighten the hardware completely so the panel can be tilted outward later for installation of some wires near the front of the chassis.

The next two steps describe the mounting of the output transistors on the back panel heat fins. A thin uniform film of silicon thermal compound is needed on the mating surfaces to provide maximum heat transfer from a transistor to the heat sink. Excess compound will be messy, and is a

disadvantage, since the compound is intended only to fill in minute voids between flat surfaces.

This thermal compound can be most annoying if carelessly handled. Clean up any excess with paper tissues as you go along. It is difficult to remove from clothing, and the best removal agent, if needed, is Freon—a degreasing agent available in a pressure spray can at electronic supply houses.

One of the easiest ways to handle this compound is to apply it with the blade of a screwdriver or a toothpick. However, the screwdriver used should be other than the one employed to install the hardware.

Set the chassis aside and return now to the back panel. The eight output transistors plug into sockets on the heat fins. Note that the holes for the transistor pins in the sockets are off-center. The longer end is identified with an "E" stamped in the fiber adjacent to a lug, and the shorter end is stamped with a "B" also adjacent to a lug. The center "C" lug is unmarked.

The metal insulators (shaped like the transistors) are hard-anodized for excellent thermal conductivity with electrical isolation. Do not scratch them. Apply the thermal compound in a *very thin film* to both surfaces while holding it by the tab at the "B" end. Position the insulator correctly, and install it on the transistor. Then the combination is installed on the outside of the heat fin and plugged into a socket on the inside. The longer "E" end of each socket is positioned to the right, as viewed in the Pictorial Diagram.

The simplest procedure seems to be the following: after placing the compound coated insulator on the transistor, *wipe each transistor pin clean of all compound.* Then position the combination to properly match the mounting holes and press it against the heat fin on the outside with a *slight* twisting motion to assure uniform contact. While holding it in place, snap the socket over the pins from the inside. When firmly engaged, this will hold each assembly temporarily so that the screws can be installed from the outside in one final operation to minimize smearing.

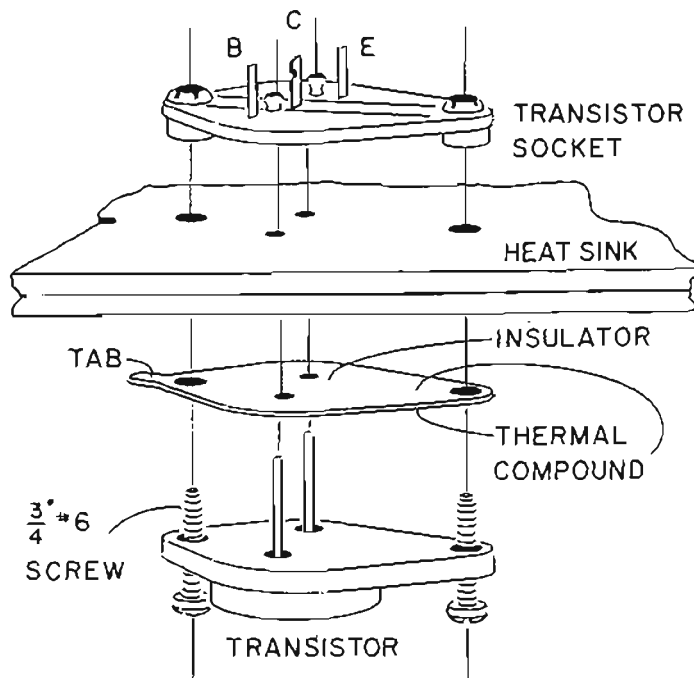

19() Select the four transistors, Part #561357 (2N6029 or 2N6030), four metal insulating wafers, four transistor sockets, the thermal compound, and eight of the #6 *sheet metal* screws (coarse threads with slightly tapered ends). Do *not* confuse these transistors with the four 571105 transistors, which look the same, but will be mounted in the next step. First check to see that the transistor pins are straight. These four transistors will be mounted from the *outside* at the BOTTOM of the four heat fins in positions Q2A and Q2B. Apply a *thin* film of compound to both sides of the insulator, position it correctly, and install it over the transistor pins. *Wipe the pins clean*, and plug each assembly through the heat fin into the transistor socket. Secure each with two sheet metal screws.

20() Select the four transistors, Part #571105 (2N5629 or 2N5630), the other four insulating wafers, the four remaining sockets, and the last eight $\frac{3}{4}$ " sheet metal screws. Check for straight transistor pins. Apply a thin film of compound to the insulating wafers as before, wipe the pins clean, install these from the *outside* at the TOP of the heat fins in positions Q1A and Q1B, and snap them into the sockets. Secure with the sheet metal screws.

This completes the need for the compound. Wipe off all the excess, including the threads of the transistor mounting screws, to avoid smears as you complete construction.

21() Select the four perforated black transistor covers. Their installation requires *removal* of the two sets of #6 hardware used to attach the tops of the heat fins to the back panel, and loosening the two sets of hardware used to attach the bottoms of the heat fins. Slip one end of a cover—they are made symmetrically—under the hardware at the bottom, and re-install the hardware at the top. Tighten all sixteen screws *very* firmly.

WIRING THE HEAT SINK AND PC-43

Be particularly careful handling the preassembled audio circuit boards, for they represent a substantial portion of the cost of the QSA-300. Many of the components stand upright on the board, and careless handling can unduly flex and possibly break their leads. There are also four adjustable potentiometers on each circuit board whose values (positions) have been precisely set under operational test conditions for optimum performance. *Be very careful* that none of these is disturbed when handling the boards.

In the following steps, two sets of brackets for checking off, one below the other, are indicated: () This means ().

that the same instruction is to be completed *twice*, first for the right side of the assembly, and second for the left, before continuing to the next step. The wire lengths, directions, and identifying numbers are identical for both sides.

1() Select the PC-43 audio circuit board, the two () Z-shaped metal mounting brackets, and four sets of #6 hardware. Install the brackets on the *foil side* (not the components side) of the board, with the long side against the board, and the first bend at the row of holes at the bottom. Insert the screws first through the board from the components side, then through the bracket, with each nut against the bracket. Firmly tighten the hardware.

2() Place the back panel assembly in front of you, so () that it lies on its heat fins, and positioned so that the top is toward you. Place PC-43, *foil side* up, against the bottom of the back panel, so that holes #12 and #15 on the board are adjacent to input socket lugs #4 and #1, respectively. Support the board about $2\frac{1}{2}$ " off the work surface on a box, such as a tissue box, so that the row of holes on PC-43 is adjacent to the bottom flange of the back panel.

In succeeding steps connections will be made to plated through holes on PC-43. A good connection is more certain if the tip of the wire is first "tinned" by heating it and applying a *very small amount* of solder before it is connected to the hole. Insert the wire in the hole so that bare wire is visible on *both* sides of the board. Let the soldering iron contact the junction of wire and board circuitry as you feed solder to the junction. Solder should flow smoothly from the circuitry, *around the hole* to completely surround the wire. Keep the wire steady while the connection cools, and then wiggle it to make sure the connection is secure. If in doubt, reheat the connection and add more solder.

Do *not* add solder to the holes before a wire is inserted. If you do, it will be difficult to find the hole to clear it. However, should you solder a wire in error to a wrong hole, first remove the wire by using the iron, and while the solder is still hot, push a toothpick through the hole to clear it.

The following connections will be made to the foil side of the board.

3() Prepare a $2\frac{3}{4}$ " (7 cm) black wire, but remove $\frac{3}{8}$ " () (1 cm) of insulation from one end and the conventional $\frac{1}{4}$ " (.6 cm) of insulation from the other. Pass the longer prepared end through input socket lug #3 to lug #2, and solder both lugs. Connect the short-prepared end to hole #13 on the board (S).

4() Prepare a 2" (5 cm) yellow wire, by removing the () conventional $\frac{1}{4}$ " (.6 cm) of insulation from both ends. Connect one end to hole #4 (S). Connect the other end to speaker fuse holder lug #3 (S).

5() Prepare another 2" (5 cm) yellow wire. Connect one () end to hole #23 (S). Connect the other end to speaker fuse holder lug #2 (S).

These wires will have stabilized the position of PC-43 relative to the back panel assembly.

6() Prepare a $2\frac{1}{4}$ " (5.5 cm) blue wire. Connect one end () to hole #12 (S). Connect the other end to input socket lug #4 (S).

7() Prepare a $2\frac{1}{4}$ " (5.5 cm) yellow wire. Connect one () end to hole #15 (S). Connect the other end to input socket lug #1 (S).

8() Prepare a $1\frac{3}{4}$ " (4.5 cm) blue wire. Connect one end () to speaker fuse holder lug #4. Connect the other end to red binding post lug #4.

9() Select a .27 ohm, 5 watt resistor, and cut its leads () to $\frac{5}{8}$ " (1.6 cm) each. Do not confuse it with the .33 ohm resistors, which look the same. Connect one lead to speaker fuse holder lug #4 (S-2). Connect the other lead to red binding post lug #4 (S-2).

Each lug of the 6-lug terminal strips T-1 and T-2 has two holes, the conventional one at the tip, and the other at the base through the insulating material. For ease of connection, several of the steps following will indicate soldering to the *tip* or to the *base* of a lug on these terminal strips. The two holes will be soldered independently.

- 10() Prepare a 3½" (9 cm) blue wire. Connect one end () to hole #5 (S). Connect the other end to T-2 lug #12 at the *base*.
- 11() Select a .33 ohm, 5 watt resistor, cut its leads to () ⅝" (1.6 cm) each, and bend the leads 90° to its body. Do not confuse it with the .27 ohm resistors. Connect one lead from the right to T-2 lug #12 at the base (S-2). *Do not place the resistor against T-2, but mount it about ⅛" (.3 cm) to the right of the terminal strip.* Connect the other lead to T-2 lug #10 at the base (S).
- 12() Select another .33 ohm, 5 watt resistor, cut its leads () to 1¼" (3.2 cm), and bend the leads almost 90° to its body. Connect one lead from the right to T-2 lug #12 at the *tip* (S). Position the resistor body to the right of the other .33 ohm resistor, leaving a small space between them. Connect the other lead to T-2 lug #9 at the base (S).
- 13() Prepare a 4" (10 cm) yellow wire. Connect one end () to hole #8 (S). Connect the other end to T-2 lug #10 at the *tip*.
- 14() Prepare a 1¼" (3 cm) yellow wire. Connect one () end to T-2 lug #10 at the *tip* (S-2). Connect the other end to Q2B lug E.

All diodes supplied have their cathode end marked with a stripe, an arrow head, or a colored tip. It is this *marked* cathode end that will be referred to in several subsequent steps. The sketch below shows the diodes more than double size.

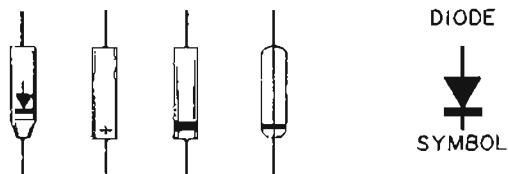

- 15() Select one of the diodes, part #544012. Cut the lead () on the *marked* end to ½" (1.3 cm), cut the other lead to ¾" (2 cm), and bend the leads 90° to its body. Connect the lead on the *marked* end to Q2B lug E (S-2). Connect the other lead to Q2B lug C. Notice that lug C has a notch in it rather than a hole. Hook the lead in the notch until soldering is called for.
- 16() Prepare a 4" (10 cm) blue wire. Connect one end () to hole #11 (S). You may wish to temporarily insert a toothpick in hole #10 to prevent it from filling with solder as hole #11 is soldered. Bend a small hook around the other end, and connect it to Q2B lug C (S-2).
- 17() Prepare a 3¾" (9.5 cm) black wire. Connect one () end to hole #7 (S). Connect the other end to Q2B lug B (S).
- 18() Prepare a 4½" (11.5 cm) yellow wire. Connect one () end to hole #6 (S). Connect the other end to T-2 lug #9 at the *tip*.

- 19() Prepare a 2¼" (6 cm) yellow wire. Connect one () end to T-2 lug #9 at the *tip* (S-2). Connect the other end to Q1B lug E.
- 20() Select another of the diodes, part #544012. Cut the () lead on the *marked* end to ¾" (2 cm), cut the other lead to ½" (1.3 cm), and bend the leads 90° to its body. Connect the *lead without marking* to Q1B lug E (S-2). Connect the *marked* end lead to the notch in Q1B lug C. Note that the *marked* end of this diode and the one connected to Q2B point in opposite directions.
- 21() Prepare a 6" (15.5 cm) blue wire. Connect one () end to hole #3 (S). Temporarily insert a toothpick in hole #2, if desired. Bend a small hook around the other end, and connect it to Q1B lug C (S-2).
- 22() Prepare a 5¾" (14.5 cm) black wire. Connect one () end to hole #9 (S). Connect the other end to Q1B lug B (S).
- 23() Prepare a 1¾" (4.5 cm) yellow wire. Connect one () end to speaker fuse holder lug #1. Connect the other end to red binding post lug #1.
- 24() Select the last .27 ohm, 5 watt resistors, and cut the () leads to ⅝" (1.6 cm) each. Connect one lead to speaker fuse holder lug #1 (S-2). Connect the other lead to red binding post lug #1 (S-2).
- 25() Prepare a 4¾" (12 cm) blue wire. Connect one end () to hole #22 (S). Connect the other end to T-1 lug #6 at the *base*.
- 26() Select a .33 ohm, 5 watt resistor, cut its leads to () ⅝" (1.6 cm) each, and bend the leads 90° to its body. Connect one lead from the left to T-1 lug #6 at the base (S-2). Mount the resistor about ⅛" (.3 cm) to the left of the terminal strip. Connect the other lead to T-1 lug #4 at the base (S).
- 27() Select the last .33 ohm, 5 watt resistors, cut the leads () to 1¼" (3.2 cm), and bend the leads almost 90° to its body. Connect one lead from the left to T-1 lug #6 at the *tip* (S). Position the resistor body to the left of the other .33 ohm resistor, leaving a small space between them. Connect the other lead to T-1 lug #3 at the base (S).
- 28() Prepare a 5¾" (14.5 cm) yellow wire. Connect one () end to hole #19 (S). Connect the other end to T-1 lug #4 at the *tip*.
- 29() Prepare a 2½" (6.5 cm) yellow wire. Connect one () end to T-1 lug #4 at the *tip* (S-2). Connect the other end to Q2A lug E.
- 30() Select a diode, part #544012. Cut the lead on the () *marked* end to ½" (1.3 cm), cut the other lead to ¾" (2 cm), and bend the leads 90° to its body. Connect the *marked* end lead to Q2A lug E (S-2). Connect the other lead to the notch in Q2A lug C.
- 31() Prepare a 4" (10 cm) blue wire. Connect one end to () hole #17 (S). Temporarily insert a toothpick in hole #16, if desired. Bend a small hook around the other end, and connect it to Q2A lug C (S-2).
- 32() Prepare a 4" (10 cm) black wire. Connect one end () to hole #20 (S). Connect the other end to Q2A lug B (S).

- 33() Prepare a $5\frac{3}{4}$ " (14.5 cm) black wire. Connect one () end to hole #18 (S). Connect the other end to Q1A lug B (S).
- 34() Prepare a $5\frac{3}{4}$ " (14.5 cm) yellow wire. Connect one () end to hole #21 (S). Connect the other end to T-1 lug #3 at the tip.
- 35() Prepare a $1\frac{3}{4}$ " (4.5 cm) yellow wire. Connect one () end to T-1 lug #3 at the tip (S-2). Connect the other end to Q1A lug E.
- 36() Select another of the diodes, part #544012. Cut the () lead on the *marked* end to $\frac{3}{4}$ " (2 cm), cut the other lead to $\frac{1}{2}$ " (1.3 cm), and bend the leads 90° to its body. Connect the *lead without marking* to Q1A lug E (S-2). Connect the marked end lead to the notch in Q1A lug C. Note that the marked end of this diode and the one connected to Q2A point in opposite directions.
- 37() Prepare a $5\frac{3}{4}$ " (14.5 cm) blue wire. Connect one () end to hole #24 (S). Temporarily insert a toothpick in hole #25, if desired. Bend a small hook around the other end, and connect it to Q1A lug C (S-2).

The work you have finished should look like the accompanying photograph.

This completes the soldering to holes on the foil side of each PC-43 board, and to most of the connections on the back panel. Now you should check all your connections.

See that no solder blobs or excess wire connects other than the intended terminal. Cut off any excess wire on the other side of a connection with your side cutters. Turn the assembly over and cut off any excess wire (more than $\frac{1}{8}$ "—2 cm) from the soldered holes on the boards. Now shake it to remove any bits of solder or pieces of wire or insulation.

The following holes and lugs are without connection: PC-43 holes #1, #2, #10, #14, #16, #25 and #26; terminal strips T-1 lugs #1, #2 and #5, and T-2 lugs #7, #8 and #11; all *black* binding posts; all thermal sensors.

- 38() Select the last two #6 screws and two *KEP* nuts. () Gently but firmly turn the entire PC-43 board on its connected wires until the board is approximately in its final position parallel to the inside of the back panel. Insert screws in the small holes in the back panel near the bottom from the outside (ignore the holes in the flanges), then through the holes in the Z-brackets, and secure the brackets to the back panel with the nuts on the inside. See that the wires do not interfere with the Z-brackets or the U-shaped heat sink attached to PC-43. The screws should remain finger tight until the next step.
- 39() Select two black sheet metal screws with Phillips () heads. Insert the screws in the back panel below the thermal sensor from the outside, and then through the holes in the U-shaped heat sink attached to PC-43. Securely tighten this hardware and the screws connecting the Z-brackets to the back panel.

Now turn to page 15.

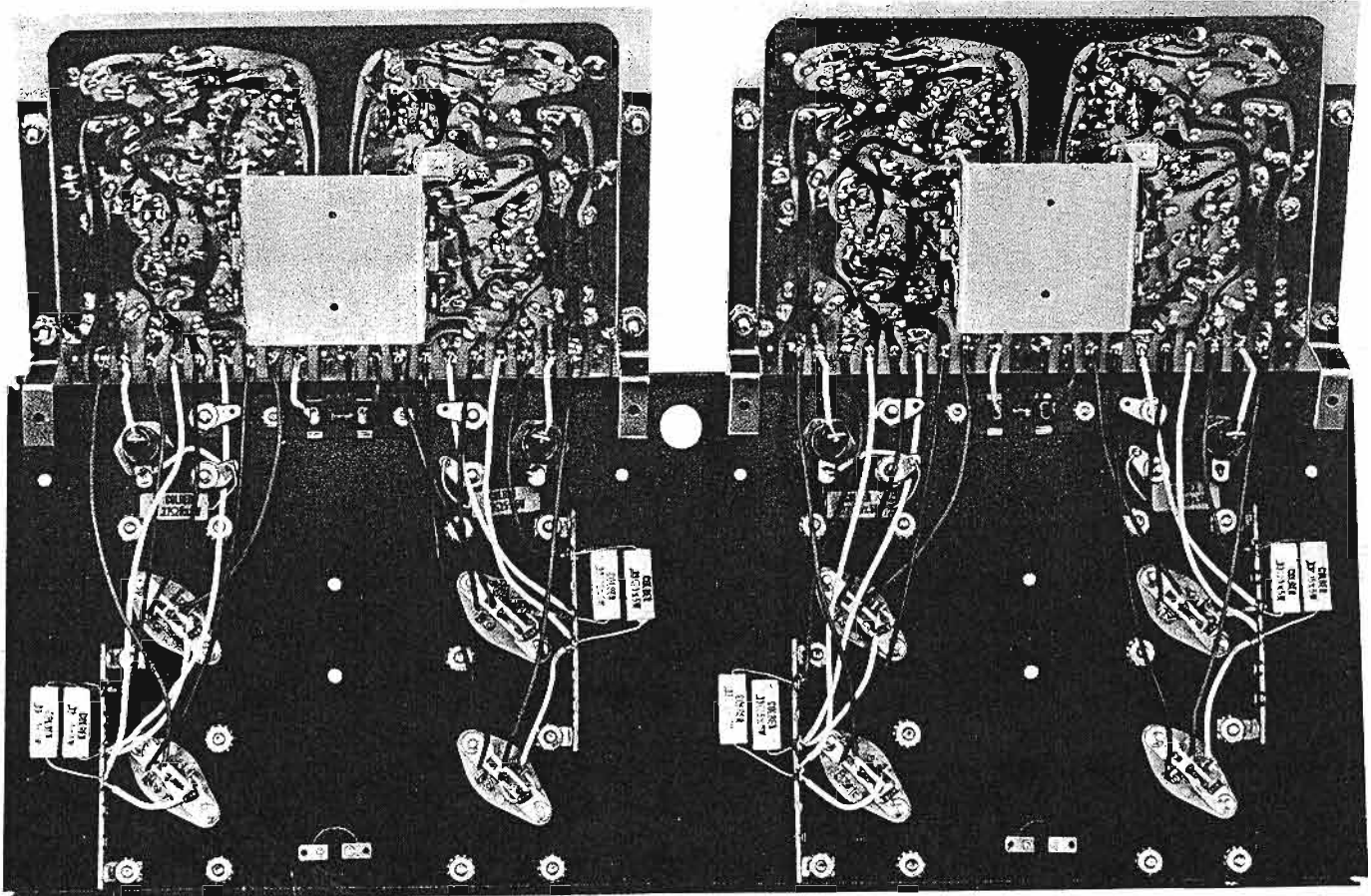

SCHEMATIC DIAGRAM

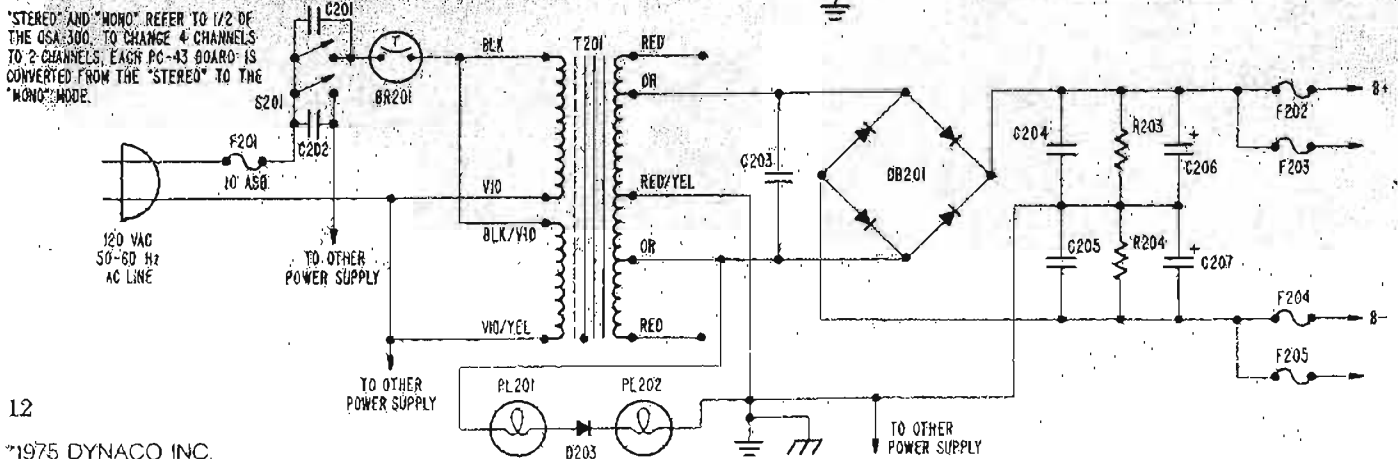
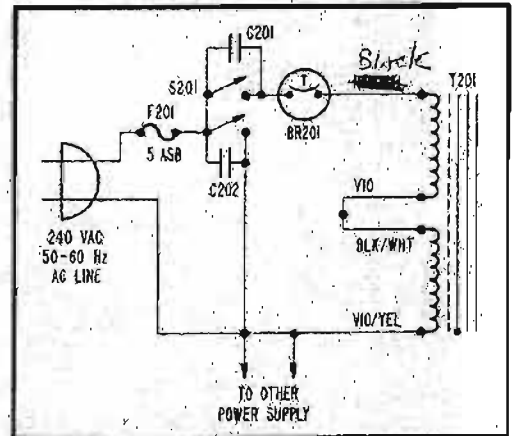
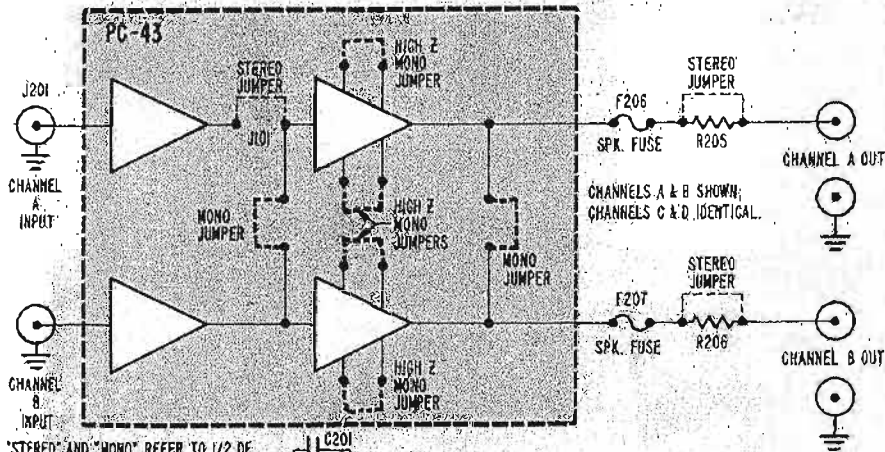
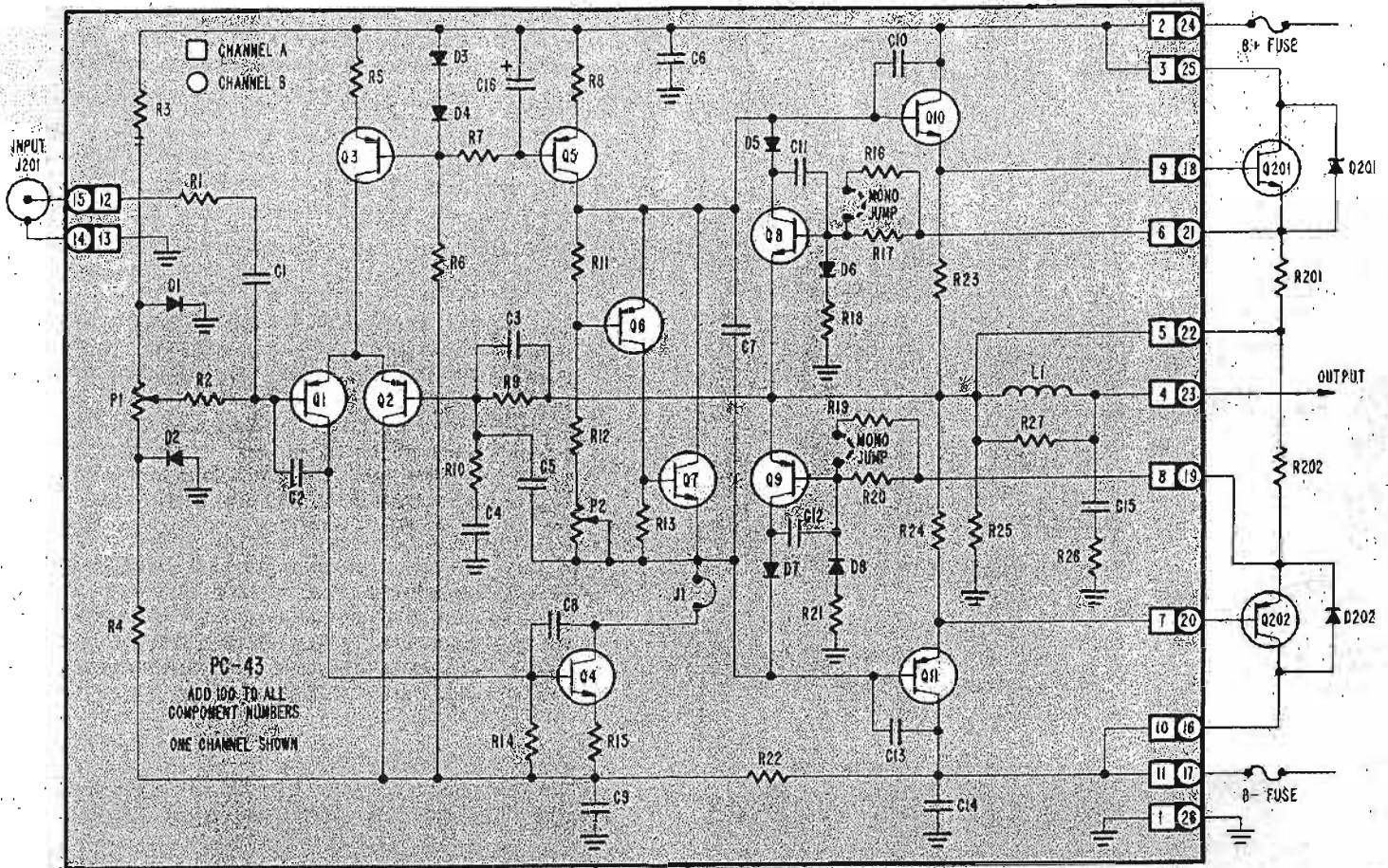

COMPONENT VALUES

All resistors are 1/4 w., 5% unless otherwise indicated.

	PART #		PART #		
R101	1,000 ohms	119102	D202	Silicon diode, 1 a., 200 PRV	544012
R102	47,000 ohms	119473	D203	Silicon diode, 1 a., 200 PRV	544012
R103	33,000 ohms	119333	DB201	Silicon bridge rectifier, 25 a., 200 PRV	544504
R104	33,000 ohms	119333	BR201	Thermal Breaker, 15 a., 75° C	342011
R105	220 ohms	119221	F201	Fuse, 10 ampere, 3AG	342016
R106	100,000 ohms	119104	F201	Fuse, 5 ampere, 3AG (240 v. alternate)	342050
R107	1,000 ohms	119102	F202	Fuse, 4 ampere, 3AG	342004
R108	100 ohms	119101	F203	Fuse, 4 ampere, 3AG	342004
R109	24,000 ohms	119243	F204	Fuse, 4 ampere, 3AG	342004
R110	1,000 ohms	119102	F205	Fuse, 4 ampere, 3AG	342004
R111	1,000 ohms	119102	F206	Fuse, 3 ampere, 3AG	342003
R112	2,200 ohms	119222	F207	Fuse, 3 ampere, 3AG	342003
R113	1,000 ohms	119102	C101	4.7 µf, 15 v. tantalum	282505
R114	560 ohms	119561	C102	150 pf, 500 v., 10% disc	238151
R115	4.7 ohms	119047	C103	56 pf, 500 v., 10% disc	234560
R116	560 ohms	119561	C104	50 µf, 25 v. electrolytic	282500
R117	560 ohms	119561	C105	10 pf, 500 v., 10% disc	234100
R118	7,500 ohms	119752	C106	0.1 µf, 100 v., 20% disc	224104
R119	560 ohms	119561	C107	0.1 µf, 100 v., 20% disc	224104
R120	560 ohms	119561	C108	22 pf, 500 v., 10% disc	234220
R121	7,500 ohms	119752	C109	50 µf, 75 v. electrolytic	284500
R122	100 ohms	119101	C110	150 pf, 500 v., 10% disc	238151
R123	47 ohms	119470	C111	0.01 µf, 100 v., 20% disc	234103
R124	47 ohms	119470	C112	0.01 µf, 100 v., 20% disc	234103
R125	1,200 ohms, 2 w., 10%	118122	C113	150 pf, 500 v., 10% disc	238151
R126	10 ohms, 2 w., 10%	110100	C114	0.1 µf, 100 v., 20% disc	224104
R127	Included with L101		C115	0.1 µf, 100 v., 20% disc	224104
R201	0.33 ohms, 5 w., 5%	120033	C116	50 µf, 6 v. electrolytic	281476
R202	0.33 ohms, 5 w., 5%	120033	C201	0.02 µf, 500 v., 20% disc	227203
R203	10,000 ohms, 1 w., 10%	115103	C202	0.02 µf, 500 v., 20% disc	227203
R204	10,000 ohms, 1 w., 10%	115103	C203	0.02 µf, 500 v., 20% disc	227203
R205	0.27 ohms, 5 w., 5%	120027	C204	0.1 µf, 100 v., 20% disc	224104
R206	0.27 ohms, 5 w., 5%	120027	C205	0.1 µf, 100 v., 20% disc	224104
L101	Audio choke wound on 1 ohm, 5 w., 5%	453002	C206	10,000 µf, 80 v. electrolytic	284109
P101	5,000 ohms trimpot	190502	C207	10,000 µf, 80 v. electrolytic	284109
P102	1,000 ohms trimpot	190103	PL201	Lamp, #53	526053
Q101	PNP transistor, 2N4889	562889	PL202	Lamp, #53	526053
Q102	PNP transistor, 2N4889	562889	S201	Switch, power	334021
Q103	PNP transistor, 2N4889	562889	T201	Transformer, power	464030
Q104	NPN transistor, BF257	572100			
Q105	PNP transistor, 2N4889	562889			
Q106	PNP transistor, BC308B	567070			
Q107	NPN transistor, SE6020	577021			
Q108	NPN transistor, MPSA20, BC237A	577020			
Q109	PNP transistor, BC308B	567070			
Q110	NPN transistor, TIP31C (Select)	577131			
Q111	PNP transistor, TIP32C (Select)	567132			
Q201	NPN transistor, 2N5630	571105			
Q202	PNP transistor, 2N6030	561357			
D101	Silicon diode, 1N4148	543148			
D102	Silicon diode, 1N4148	543148			
D103	Silicon diode, 1N4148	543148			
D104	Silicon diode, 1N4148	543148			
D105	Silicon diode, 1N4148	543148			
D106	Silicon diode, 1N4148	543148			
D107	Silicon diode, 1N4148	543148			
D108	Silicon diode, 1N4148	543148			
D201	Silicon diode, 10a., 200 PRV	544012			

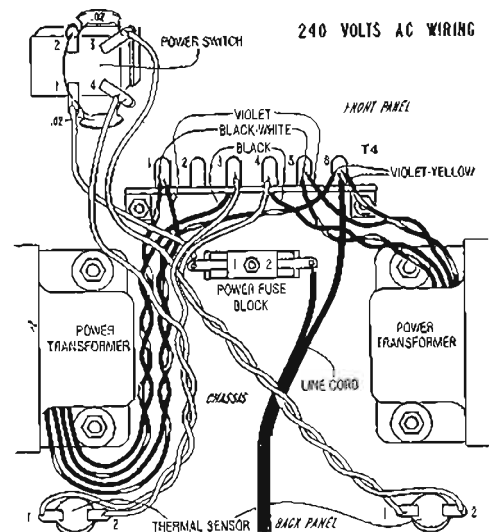

CIRCUIT DESCRIPTION

The components in the QSA-300 have been selected to protect against failure, and all parts are operated conservatively to assure unaltered performance and proper operation for many years. The semiconductors have been thoroughly researched and selected for minimum noise and distortion in sustained use, and the printed circuit boards associated with audio signals have been pretested in the circuit to insure that this unit will meet or exceed all specifications.

The amplifier stages are fully DC coupled, with a differential pair for the input and a fully complementary output stage. Each power supply has a full wave bridge with 10,000 mfd capacitors on both the plus "+" and minus "-" supplies to provide excellent filtering and dynamic load stability. Protection circuitry includes two separate power supply fuses for each channel, volt-amp limiting, individual thermal breakers for each two channels, output fuses to protect the amplifier and speakers, and an AC line fuse.

DIFFERENTIAL AMPLIFIER

Transistors Q101 and Q102, the input differential pair, are driven from a constant current source, transistor Q103, to optimize parameters for the input pair. Potentiometer P101 adjusts the reference voltage for the base of Q101, which in turn balances transistors Q101 and Q102 to control the DC offset of the amplifier.

BIAS ADJUSTMENT

An adjustable electronic equivalent of a zener diode with negligible dynamic resistance is formed by transistors Q106 and Q107, resistors R111, R112 and R113, and poten-

tiometer P102. Thus the signal sees the bases of transistors Q110 and Q111 tied together. Potentiometer P102 adjusts the zener voltage to bias the amplifier for Class AB operation, and therefore determines the quiescent (idle) current in the driver and output stages. Complete circuit stability is assured by mounting transistor Q106 to thermally track the driver and output transistors, and to provide temperature compensation for the amplifier.

DRIVER AND OUTPUT STAGES

The driver and output stages of the QSA-300 are of the full complementary configuration. Transistors Q110 and Q201 form a Darlington pair for the positive half of the signal, and transistors Q111 and Q202 form another Darlington pair for the negative half of the signal.

PROTECTION

A volt-amp limiter circuit protects both the positive and negative halves of the driver and output stages. When the current through resistor R201 exceeds a preset limit, its resulting voltage drop turns on transistor Q108, and limits the drive to transistor Q110 until the current is reduced for the positive half of the circuit. The same operation takes place to protect the negative amplifier circuit through resistor R202 and transistor Q109, and limits the drive to transistor Q111. Diodes D201 and D202 across the output devices limit possible reverse voltage from inductive loads to 700 millivolts maximum. If the heat sink temperature of a pair of channels rises to 75° C, a thermal breaker will shut down that power supply until that section cools down.

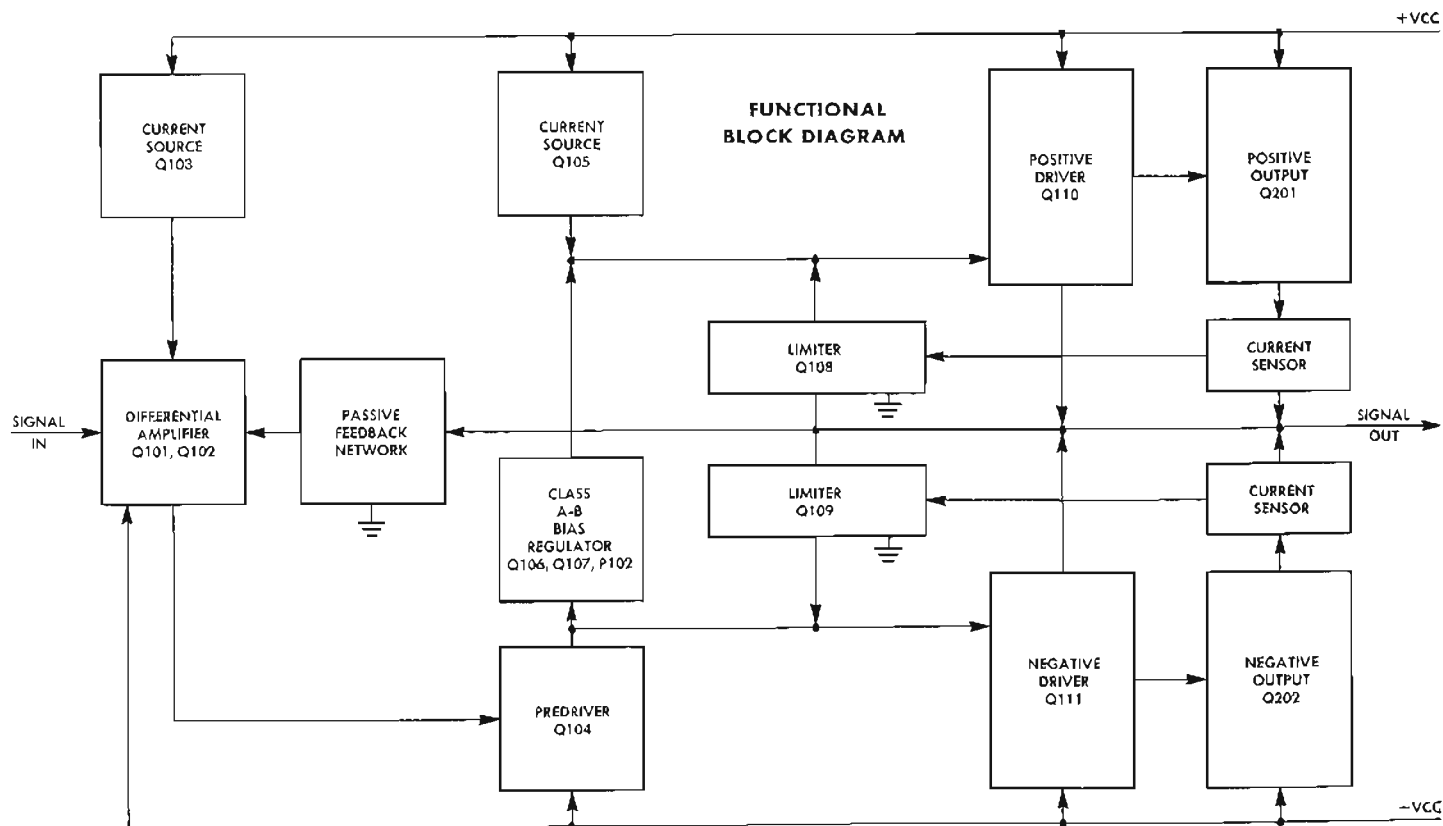

WIRING THE CHASSIS

Set aside the back panel, and place the main chassis assembly in front of you, positioned as shown in the Pictorial Diagram.

In the following steps, two sets of brackets following a step number *may* be indicated. If so, the same instruction is to be completed identically for the right and left sides of the assembly. If only one bracket set is indicated complete the instruction just once.

- 1() Strip the insulation from a 2 $\frac{3}{4}$ " (7 cm) heavy white wire. Connect one end of the bare wire to the solder lug GL1 at the base of C2 for the *left* side. Connect the other end to the solder lug GL2 at the base of C1 for the *right* side. Solder both connections very securely. "Tin" the entire length of this bare wire with solder and your hot iron so that the wire is solid and shiny.
- 2() Prepare a 7 $\frac{1}{2}$ " (19 cm) yellow wire, but remove () 1" (2.5 cm) of insulation from one end and the usual $\frac{1}{4}$ " (.6 cm) from the other. Feed the long-stripped end from the right through B+ fuse block lug #3 to lug #2, and then solder both connections. This block lies between the pair of large capacitors, C1 and C2. Connect the other end to C2 lug #3.
- 3() Select one of the 10,000 ohm, 1 watt resistors (brown- () black-orange), bend its leads almost 90° to its body, and cut the leads to $\frac{5}{8}$ " (1.6 cm) each. Connect one lead to C2 lug #3. Connect the other lead to C2 lug #4.
- 4() Select one of the .1 μ f disc capacitors, and cut its () leads to $\frac{3}{4}$ " (2 cm) each. Do not confuse it with the .02 μ f disc capacitors, which look similar. Connect one lead to C2 lug #3. Connect the other lead to C2 lug #4.
- 5() Prepare a 9 $\frac{1}{4}$ " (23.5 cm) yellow wire in the usual manner. Connect one end to the *right* side C2 lug #3 (S-4). We suggest crimping this wire around the lug if the lug hole is already filled with wires. Connect the other end to the *right* side diode block lug #3 (S). A considerable amount of heat is required to solder the lugs on the diode blocks.
- 6() Prepare a 13 $\frac{3}{4}$ " (35 cm) yellow wire. Connect one end to the *left* C2 lug #3 (S-4). Crimp this wire around the lug if the lug hole is filled with wires. Connect the other end to the *left* diode block lug #3 (S).
- 7() Prepare a 10 $\frac{3}{4}$ " (27 cm) white wire, but remove $\frac{1}{2}$ " (1.3 cm) of insulation from one end, and the usual from the other. Connect the short-stripped end to the *right* C2 lug #4 (S-3). Bend a hook at the other end, and connect it to the right end of the bare wire between GL1 and GL2 (S). Although a total of 14 wires will eventually be connected to this bare wire, we recommend soldering each one individually.
- 8() Prepare a 5 $\frac{3}{4}$ " (14.5 cm) white wire, but remove $\frac{1}{2}$ " (1.3 cm) of insulation from one end, and the usual from the other. Connect the short-stripped end to the *left* C2 lug #4 (S-3). Bend a hook at the other end, and connect it to the left end of the bare wire between GL1 and GL2 (S).
- 9() Prepare a 2 $\frac{1}{2}$ " (6.5 cm) blue wire in the usual () manner. Connect one end to B+ fuse block lug #4 (S). Connect the other end to B+ fuse block lug #1.
- 10() Prepare a 6 $\frac{3}{4}$ " (17 cm) blue wire. Connect one end () to B+ fuse block lug #1 (S-2). Connect the other end to C1 lug #2.
- 11() Select the last 10,000 ohm, 1 watt resistors (brown- () black-orange), bend the leads almost 90° to its body, and cut the leads to $\frac{5}{8}$ " (1.6 cm) each. Connect one lead to C1 lug #2. Connect the other lead to C1 lug #1.
- 12() Select the last .1 μ f disc capacitors, and cut the leads () to $\frac{3}{4}$ " (2 cm) each. Connect one lead to C1 lug #2. Connect the other lead to C1 lug #1.
- 13() Prepare a 12" (30.5 cm) blue wire. Connect one end to the *right* C1 lug #2 (S-4). Crimp this wire around the lug if the lug hole is filled with wires. Connect the other end to the *right* diode block lug #1 (S).
- 14() Prepare a 6" (15.5 cm) white wire, but remove $\frac{1}{2}$ " (1.3 cm) of insulation from one end, and the usual from the other. Connect the short-stripped end to the *right* C1 lug #1 (S-3). Bend a hook at the other end, and connect it next to the other wire at the right end of the bare wire between GL1 and GL2 (S).
- 15() Prepare a 9 $\frac{1}{2}$ " (24 cm) blue wire in the usual manner. Connect one end to the *left* C1 lug #2 (S-4). Crimp this wire around the lug if the lug hole is filled with wires. Connect the other end to the *left* diode block lug #1 (S).
- 16() Prepare a 10 $\frac{1}{4}$ " (26 cm) white wire, but remove $\frac{1}{2}$ " (1.3 cm) of insulation from one end, and the usual from the other. Connect the short-stripped end to the *left* C1 lug #1 (S-3). Bend a hook at the other end, and connect it next to the other wire at the left end of the bare wire between GL1 and GL2 (S).
- 17() Prepare a 10" (25.5 cm) white wire, but remove $\frac{1}{2}$ " (1.3 cm) of insulation from one end, and the usual from the other. Connect the short-stripped end to the *right* terminal strip T-3 lug #2 at the base (S). Bend a hook at the other end, and connect it next to the other wires near the right end of the bare wire between GL1 and GL2 (S).
- 18() Prepare a 9 $\frac{3}{4}$ " (25 cm) white wire, but remove $\frac{1}{2}$ " (1.3 cm) of insulation from one end, and the usual from the other. Connect the short-stripped end to the *left* T-3 lug #2 at the base (S). Bend a hook at the other end, and connect it next to the other wires near the left end of the bare wire between GL1 and GL2 (S).
- 19() Select one of the .02 μ f disc capacitors, and cut its leads to $\frac{3}{8}$ " (1 cm) each. Connect one lead to power switch lug #4. Tuck the capacitor under the switch, and connect the other lead to power switch lug #1.
- 20() Select another of the .02 μ f disc capacitors, and cut its leads to $\frac{3}{8}$ " (1 cm) each. Connect one lead to power switch lug #3. Place the capacitor atop the switch, and connect the other lead to power switch lug #2.

- 21() Prepare a $7\frac{1}{4}$ " (18.5 cm) white wire, but remove 1" (2.5 cm) of insulation from one end, and the usual from the other. Feed the long-stripped end through power switch lug #1 (S-2) to lug #2 (S-2). Connect the other end to power fuse block lug #1 (S).

The next two steps refer to the connection of the two lamp sockets on the front panel. If the MC-3 meter assembly kit has been obtained and is to be installed, skip these two steps.

- 22() Prepare an 8" (20.5 cm) black wire, but remove $\frac{3}{8}$ " (1 cm) of insulation from one end, and the usual from the other. Also prepare an $8\frac{1}{4}$ " (21 cm) yellow wire in the usual manner. Start with the long-stripped black wire $2\frac{3}{4}$ " (7 cm) longer than the yellow wire, and twist them uniformly together to within $\frac{3}{4}$ " (2 cm) of the other end of the black wire (the yellow wire should be about 3" [7.5 cm] longer than the end of the black wire at this end). This twisted pair, as well as the other twisted wires in this kit, should be uniformly twisted 3 full turns every 2" (5 cm). Connect the short-stripped end of the black wire to lamp sockets lug #4 (S). Connect the corresponding end of the yellow wire to lamp sockets lug #1 (S). Position the twisted wires as shown in the Pictorial Diagram, and connect the other end of the yellow wire to the *right* diode block lug #2. Bend a hook around the corresponding end of the black wire, and connect it to the *right* T-3 lug #2.

- 23() Select the remaining diode, part #544012. Connect one (either) lead to lamp sockets lug #3 (S). Connect the other lead to lamp sockets lug #2 (S). The leads will just reach if they are not cut. Note that the position of the marked end of *this* diode is not important.

Before mounting the power transformers in the next step, turn the chassis upside down and shake out any bits of solder or pieces of wire or insulation.

- 24() Select the power transformer, the four $\frac{1}{2}$ " #10 () screws (largest *remaining* hardware), the four large flat washers, and the four #10 *KEP* nuts. Mount the transformer on the *right* side with the orange, red and red-yellow leads toward the right back; mount the transformer on the *left* side with the orange, red and red-yellow leads toward the left front. Place a large washer on top of each transformer foot before the nut is installed, see that no wires interfere with any foot, and firmly secure the hardware.

The secondary voltage leads of the power transformer comprise two red leads, two orange leads, and one red-yellow lead. Each may be shortened appropriately before connection if you wish.

- 25() Connect the red-yellow lead to T-3 lug #2 at the tip.
() (S-2) for the *right* transformer; (S) for the *left* transformer.
- 26() Twist together the two red leads. Do not confuse () them with the orange leads, which will be called for in the next step. Connect one (either) red lead to T-3 lug #5 at the tip (S). Connect the other red lead to T-3 lug #4 at the tip (S).
- 27() Twist together the two orange leads. Connect one () (either) orange lead to diode block lug #4. Connect the other orange lead to diode block lug #2. You may wish to solder these connections now, even though another lead will be connected to each in the next step.

- 28() Select the last .02 μ f disc capacitors, and cut the leads () to $\frac{3}{4}$ " (2 cm) each. Strip a 1" (2.5 cm) piece of insulation from the black wire, and cut the insulation in two equal pieces. Slip a piece of insulation on each lead of the capacitor. Connect one lead to diode block lug #2. (S-3) for the *right* diode block; (S-2) for the *left* diode block. Connect the other lead to diode block lug #4 (S-2).

The primary voltage leads of the power transformer are connected in parallel for 120 volts AC line, or in series for 240 volts AC line. They comprise the black, the black-white, the violet, and the violet-yellow leads. All of them connect to T-4. Each may be shortened before connection if you wish, but allow a little extra length so that the leads may be reconnected for the other voltage option, if desired in the future.

- 29() Strip the insulation from a $\frac{3}{4}$ " (2 cm) white wire, and bend the bare wire in a $\frac{3}{8}$ " (1 cm) wide "U". Connect the "U" between T-4 lugs #5 and #6 at the base, and solder both lugs.
NOTE: If this unit is being wired for 240 volts AC line, skip step 29.

- 30() Twist together the violet and the violet-yellow leads.
() Connect the violet-yellow lead to T-4 lug #6 at the tip. Connect the violet lead to T-4 lug #5 at the tip (S-2).

NOTE: If this unit is being wired for 240 volts AC line, connect the violet-yellow lead to T-4 lug #6 at the tip. Connect the violet lead from the *right* transformer to T-4 lug #5 at the tip. Connect the violet lead from the *left* transformer to T-4 lug #1 at the tip.

- 31() Twist together the black and the black-white leads from the *right* power transformer. Connect both leads to T-4 lug #3 at the base (S-2).

NOTE: If this unit is being wired for 240 volts AC line twist together the black and the black-white leads from the *right* transformer, and instead connect the black-white lead to T-4 lug #5 at the tip (S-2). Connect the black lead to T-4 lug #4 at the base (S).

- 32() Twist together the black and the black-white leads from the *left* power transformer. Connect both leads to T-4 lug #2 at the base (S-2).

NOTE: If this unit is being wired for 240 volts AC line, twist together the black and the black-white leads from the *left* transformer, and instead connect the black-white lead to T-4 lug #1 at the tip (S-2). Connect the black lead to T-4 lug #3 at the base (S).

FINAL ASSEMBLY

- 1() Select the back panel assembly, and two black sheet metal screws with Phillips heads. Place the panel in position at the back edge of the chassis. Insert the screws only in the corner hole at each end. The screws cut their own thread and therefore some force is required. Do not tighten the screws completely so the panel can be tilted outward for working.

In the steps following connections will be completed between the PC-43 boards or other parts on the back panel and parts on the main chassis. Connections to the boards should be made from the components side.

- 2() Prepare a 7" (18 cm) black wire, but remove $\frac{3}{8}$ " () (1 cm) of insulation from one end, and the usual from the other. Connect the short-stripped end to black binding post lug #3 (S). Bend a hook at the other end, and connect it next to the other wire near an end of the bare wire between GL1 and GL2 (S).

- 3() Prepare a 7" (18 cm) black wire, but remove $\frac{3}{8}$ " (1 cm) of insulation from one end, and the usual from the other. Connect the short-stripped end to black binding post lug #2 (S). Bend a hook at the other end, and connect it next to the other wire near an end of the bare wire between GL1 and GL2 (S).
- 4() Prepare an 11" (28 cm) black wire, but remove $\frac{3}{8}$ " (1 cm) of insulation from one end, and the usual from the other. Connect the short-stripped end to the right PC-43 hole #1 (S). Twist this wire 4 times around the other black and white wires which connect to the right end of the bare wire between GL1 and GL2, as shown in the Pictorial Diagram, so that these wires are neatly bundled together. Bend a hook at the other end, and connect it next to the other wire which is near the right end of the bare wire between GL1 and GL2 (S).
- 5() Prepare a 10" (25.5 cm) black wire, but remove $\frac{3}{8}$ " (1 cm) of insulation from one end, and the usual from the other. Connect the short-stripped end to the left PC-43 hole #26 (S). Twist this wire 4 times around the other black and white wires which connect to the left end of the bare wire between GL1 and GL2, as in the previous step. Bend a hook at the other end, and connect it next to the other wire which is near the left end of the bare wire between GL1 and GL2 (S).
- 6() Prepare a $3\frac{1}{2}$ " (9 cm) black wire, but remove $\frac{3}{8}$ " (1 cm) of insulation from one end, and the usual from the other. Connect the short-stripped end to the right PC-43 hole #26 (S). Bend a hook at the other end, and connect it next to the other wire near the right end of the bare wire between GL1 and GL2 (S).
- 7() Prepare a $3\frac{1}{4}$ " (8.5 cm) black wire, but remove $\frac{3}{8}$ " (1 cm) of insulation from one end, and the usual from the other. Connect the short-stripped end to the left PC-43 hole #1 (S). Bend a hook at the other end, and connect it next to the other wire near the left end of the bare wire between GL1 and GL2 (S).

See that each of the 14 wires connected to the bare wire between GL1 and GL2 is securely soldered. This is the main ground connection for the entire amplifier.

- 8() Prepare a 20" (51 cm) white wire, and a $25\frac{1}{2}$ " (65 cm) white wire. Start with the short wire $\frac{1}{2}$ " (1.3 cm) longer than the other wire, and twist them uniformly together to within 1" (2.5 cm) of the other end of the short wire (the long wire should be about 6" [15.5 cm] longer at this end.) Connect the 6" longer wire to power switch lug #4 (S-2). Connect the corresponding end of the other wire to T-4 lug #2 at the tip (S). Feed the pair under the bare wire between GL1 and GL2. Connect the shorter wire at the free end to the left thermal sensor lug #2 (S). Connect the remaining end to the left thermal sensor lug #1 (S).
- NOTE: If this unit is being wired for 240 volts AC line, connect the long end to power switch lug #4 as indicated (S-2), but instead connect the corresponding end to T-4 lug #3 at the tip (S).
- 9() In a similar manner, prepare a $20\frac{1}{2}$ " (52 cm) white wire, and a $25\frac{1}{2}$ " (65 cm) white wire. Start with the short wire $\frac{1}{2}$ " (1.3 cm) longer than the other wire, and twist them uniformly together to within $1\frac{1}{2}$ " (4 cm) of the other end of the short wire (the long wire should be about $5\frac{1}{2}$ " [14 cm] longer at this

end). Connect the $5\frac{1}{2}$ " longer wire to power switch lug #3 (S-2). Connect the corresponding end of the other wire to T-4 lug #3 at the tip (S). Feed the pair under the bare wire between GL1 and GL2. Connect the shorter wire at the free end to the right thermal sensor lug #1 (S). Connect the remaining end to the right thermal sensor lug #2 (S).

NOTE: If this unit is being wired for 240 volts AC line, connect the long end to power switch lug #3 as indicated (S-2), but instead connect the corresponding end to T-4 lug #4 at the tip (S).

- 10() Prepare a $4\frac{1}{4}$ " (11 cm) blue wire. Connect one end to PC-43 hole #2 (S). Connect the other end to B+ fuse block lug #5 (S).
- 11() Prepare a $3\frac{1}{4}$ " (8.5 cm) yellow wire. Connect one end to PC-43 hole #10 (S). Connect the other end to B+ fuse block lug #6 (S).
- 12() Prepare another $3\frac{1}{4}$ " (8.5 cm) yellow wire. Connect one end to PC-43 hole #16 (S). Connect the other end to B+ fuse block lug #7 (S).
- 13() Prepare a $4\frac{1}{4}$ " (11 cm) blue wire. Connect one end to PC-43 hole #25 (S). Connect the other end to B+ fuse block lug #8 (S).

This completes the soldering to the holes on each PC-43 board, and to the entire assembly, except for the connection of the line cord. Notice that hole #14 only on each board is without connection. Turn the assembly over and shake it to remove any bits of solder or pieces of wire or insulation. Leave the assembly upside down.

- 14() Select three black sheet metal screws with Phillips heads. Tilt the back panel into its upright position and secure it to the bottom of the chassis with the screws. Tighten these screws and the screws already installed on the sides.

Turn the amplifier right side up.

- 15() Select the line cord and the strain relief. Separate the two conductors of the line cord for about 2" (5 cm). Strip about $\frac{1}{4}$ " (.6 cm) of insulation from the conductors, unless the cord has been supplied with stripped ends. Mark the line cord $10\frac{1}{2}$ " (27 cm) from the stripped end with a pencil or pen. Bend the cord sharply back on itself at the marking so that a "V" is formed. Install the strain relief as shown in the sketch below. The small end of the strain relief faces the stripped end of the wire. With heavy pliers, crimp the two halves of the strain relief together around the wire to partially shape the wire before insertion. Now grasp the larger diameter portion of the strain relief with the tips of the pliers, squeeze it fully closed, and insert the combination from the outside of the back panel in the remaining large hole. Notice that the hole has slightly flat vertical sides, and therefore the strain relief installs easily in the cutout with the cord horizontal. The strain relief snaps into its locked position when fully inserted.

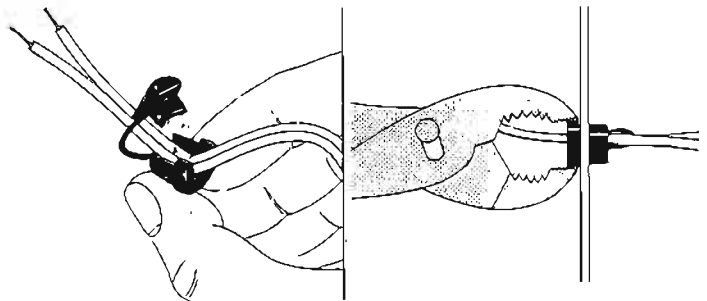

- 16() Select either conductor. Connect it to T-4 lug #6 at the tip (S-3). Select the remaining conductor, and connect it to power fuse block lug #2 (S).

This completes the wiring. You should check carefully for any insecure connections, and for any possibility of bare wires contacting other than the intended terminal.

- 17() Install the two #53 bayonet lamps in the lamp sockets on the front panel. They merely push in and turn. [If meters are being installed, ignore this step.]
- 18() Install the thirteen fuses in their respective fuse blocks and holders. The 10 ampere ceramic body fuse goes in the power fuse block. Select the four 3 ampere fuses, and install them in the speaker fuse holders on the back panel. The remaining eight 4 ampere fuses fit the B+ fuse blocks.
- 19() Select three black sheet metal screws. Turn the unit upside down, tilt the front panel into its upright position, and secure the panel to the chassis with the screws. Tighten these, and the other two screws installed previously at the corners of the panel. Turn the unit right side up. [If meters are to be installed, skip this step, and refer now to the MC-3 instructions on the back of the Pictorial Diagram in this manual before going to the next step.]

Prior to installing the decorative front plate, the cover, and the wood side panels, you may wish to test the amplifier. See that the power switch is turned off, plug the line cord into a wall outlet, and turn the power switch on. It is safe to operate the QSA-300 without connection to the inputs or the outputs. If the lamps glow and the fuses hold, there are no gross faults. Unplug the amplifier and finish your work. If the fuses fail, check your wiring and refer to the IN CASE OF DIFFICULTY section of this manual.

The general placement of wires should conform closely to the photograph of the inside of the chassis.

- 20() Select the cardboard light shield, and bend it in a "U" shape at its score markings. Install it over the lamp sockets on the front panel. To hold it in place, one side of the "U" should be slipped between the chassis and the flange of the front panel, which may require loosening one or two of the black sheet metal screws before insertion. Tighten the hardware securely after installation. [If meters have been installed, ignore this step.]
- 21() Select the extruded aluminum front plate, and the self-adhesive decorative aluminum strip. Place the extruded plate in front of you. Peel off the backing from the strip. Using the ends and bottom lip of the front plate as a guide, affix the strip to the plate. Since the strip cannot be moved once it is installed, you may wish to first try a "dry run" with the backing in place prior to final installation. [If meters have been installed, select instead the decorative strip supplied with the MC-3 kit, and install it as indicated in this step.]
- 22() Select the small piece of blue plastic. Turn the front plate over, and affix the plastic in the rectangular power opening. The adhesive on the back of the decorative strip will hold the plastic flat against it. [If meters have been installed, skip this step.]
- 23() Install the front plate on the front panel by securing it with the remaining six flat head screws and nuts. Insert the screws from the front through the counter sunk holes, and tighten the nuts on the inside. [If meters have been installed, select instead three of the short flat head screws supplied with this kit, and three of the long flat head screws supplied with the MC-3 kit. The long screws fit through the counter-

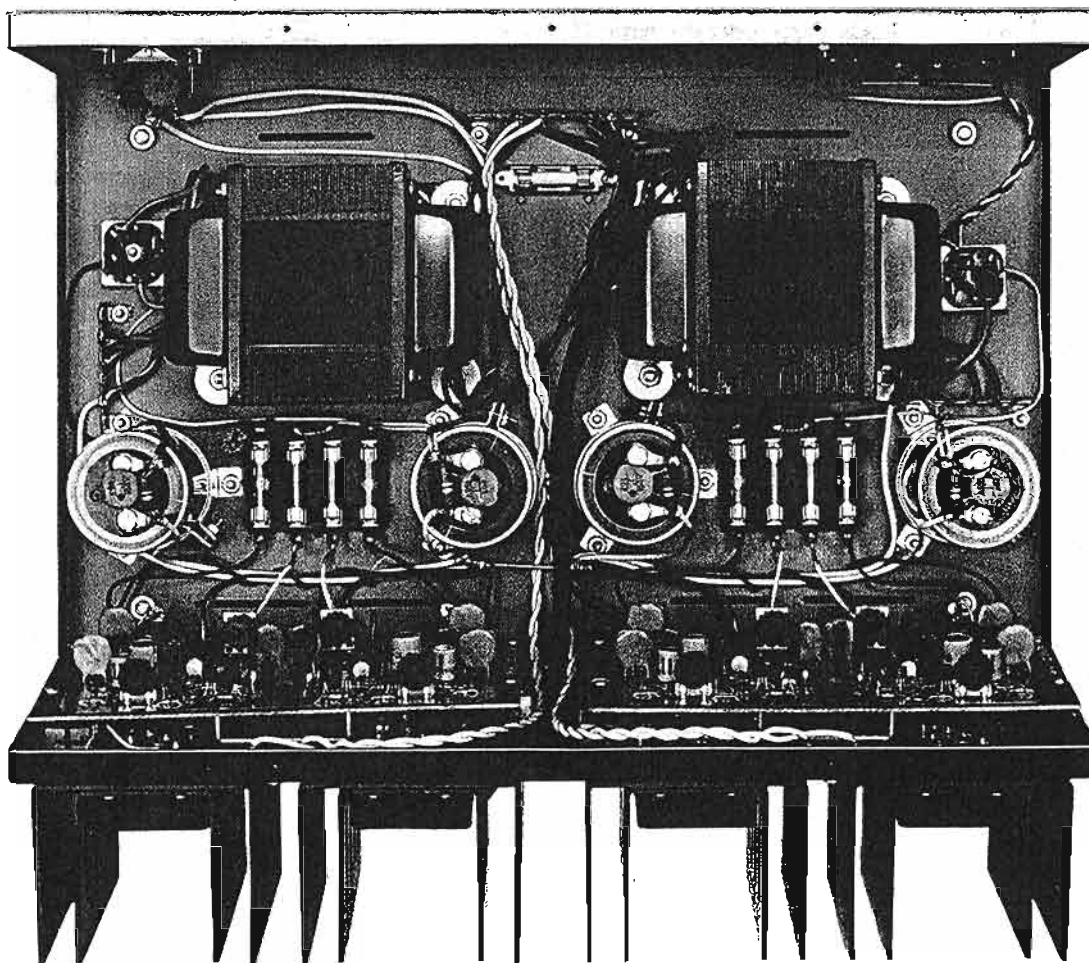

sunk holes along the top edge through the lamp housing; the short screws fit below the lamp housing. Install the nuts on the inside, but do not tighten them beyond that necessary to keep the meters snug. Also select the two black buttons supplied with the MC-3. Notice that the shafts on the meter range switch are slightly offset toward the bottom of the opening. The buttons are similarly offset, and therefore they fit easily with only one orientation. Since the buttons are difficult to remove once they have been installed, make *certain* they are correctly positioned in the opening before pushing them home.]

- 24() Peel off the protective coating from the back of the dark plastic decorative strip, mate it with the black fiber insert of the same size, and install them in the top section of the front plate. They slide in place from either end. [If meters have been installed, insert instead the fiber insert from the MC-3 kit behind the dark plastic strip. You may wipe the plastic strip and meter faces clean with a *damp* cloth and allow to air dry.]
- 25() Remove the backing from the CAUTION label, and install it vertically on the heat fin adjacent to the back panel. Similarly remove the backing from the serial number sticker, and install it on the same heat fin.
- 26() Slide on the cover so that its bottom flanges fit inside the chassis, and the perforated section lies over the two circuit boards at the back. Secure it with the remaining fourteen black Phillips head sheet metal screws—7 screws at the front and 7 at the back. CAUTION: Sheet metal screws are *not* used between the cover and the chassis.
- 27() Install the two wood panels on the sides of the unit. The cutout section in the wood faces front, and notice that one panel is drilled for the left side, and the other for the right. Use the remaining six flat black washers and the six $\frac{5}{8}$ " #6 black Phillips head screws.
- 28() Remove the protective tape, if used as suggested earlier, from the edges of the heat fins.

COMBINING CHANNELS

An individual channel of the QSA-300 may be operated at any time, provided there is no input signal to an unused channel. There is no need for any load resistor on an unused channel, for the design is completely stable.

By internal strapping on each PC-43 board, and some wiring changes to other parts of the amplifier, it is practical to combine channels for two channel (stereo) operation. This connects the outputs in *parallel*. Moreover there are TWO modes of connection for stereo use. These are:

1. *Low Impedance Mode*—optimum matching for multiple speakers connected in parallel for 2 ohms or 4 ohms, or for speakers having a nominal rating of 4 ohms, but which fall below that rating. Power output is 150 watts x 2 @ 4 ohms, with F.T.C. preconditioning.
2. *High Impedance Mode*—optimum matching for speakers having an 8 ohms or 16 ohms rating, but which do not fall much below 8 ohms. Power output is 150 watts x 2 @ 8 ohms, with F.T.C. preconditioning.

Because of the several wiring changes required, conversion to stereo operation is considered "permanent", although it is possible to restore all the original connections, if desired.

LOW IMPEDANCE CONVERSION

- 1() Remove the three black sheet metal screws with Phillips heads which secure the back panel to the bottom of the chassis. The back panel can now be tilted outward for working.
- 2() Unsolder and remove the small jumper wire J1 on () the PC-43 board. It is located to your right of the *right* Q4 transistor, as viewed from the back. Although there are two Q4 transistors on each board, only one has a jumper adjacent to it. Also remove the solder from the *lower* hole of J1 with your hot iron and a wood toothpick.
- 3() Prepare a $1\frac{3}{4}$ " (4.5 cm) black wire. Connect one () end to the lower hole of J1 (S). Remove the solder from the hole adjacent to the Q4 transistor on the *left* side, and connect the other end of the wire to the hole (S). Notice that a dotted line on the board links these two holes.

- 4() Remove the two black sheet metal screws which () secure the U-shaped heat sink on PC-43 to the back panel. Also remove the hardware which connects each Z-bracket to the back panel. The PC-43 can now be tilted forward to work on some back panel connections.
- 5() With side cutting pliers, snip out and remove the () short blue wire between speaker fuse holder lug #4 and red binding post lug #4. The .27 ohm, 5 watt resistor connected between these lugs should *not* be removed.
- 6() In a similar manner, snip out and remove the short () yellow wire between speaker fuse holder lug #1 and red binding post lug #1. The .27 ohm, 5 watt resistor should not be removed.
- 7() Prepare a 3" (7.5 cm) yellow wire. Connect one end () to red binding post lug #4 (S-2). Connect the other end to red binding post lug #1 (S-2).

This completes the modification for low impedance stereo operation. Reinstall all the hardware.

HIGH IMPEDANCE CONVERSION

To modify the QSA-300 for high impedance stereo operation, first complete all seven steps outlined above for LOW IMPEDANCE CONVERSION. The following steps are also required:

- 8() Strip the insulation from a $1\frac{1}{2}$ " (4 cm) piece of () black wire, and cut the bare wire into four equal size pieces. Bend each wire into a $\frac{1}{8}$ " (.3 cm) wide small "U".
- 9() On PC-43, locate the four *pairs* of unused holes () which are marked "mono jump". One pair is horizontally oriented about $1\frac{1}{2}$ " (4 cm) above hole #6; a second is vertically oriented about $\frac{3}{4}$ " (2 cm) above hole #7; a third is horizontally oriented about $\frac{3}{4}$ " (2 cm) above hole #19; a fourth is horizontally oriented about $1\frac{1}{2}$ " (4 cm) above holes #20 and #21. Remove the solder from each hole, and install the small U-shaped wires between each pair of holes. Solder all 8 holes securely.

- 10() Interchange the connection of the pairs of the orange () and the red leads of the power transformer, and solder each connection securely. When completed, one red lead should connect to diode block lug #4; a second red lead should connect to diode block lug #2; one orange lead should connect to T-3 lug #4; a second orange lead should connect to T-3 lug #5.
- 11() Disconnect the yellow lead at the *right* diode block lug #2, and connect it to the right T-3 lug #5 (S-2). [It will be necessary to lengthen this wire about 3" (7.5 cm) to fit.] [If meters have been installed, instead disconnect the yellow wire from the *right* T-3 lug #5, and connect it to the right diode block lug #2 (S-2).]

This completes the modification for high impedance stereo operation. Reinstall all the hardware.

When connected for low impedance or high impedance stereo operation, use only the Channel A and Channel D inputs (Channel B and Channel C inputs are disconnected). Although Channels A and B, and Channels C and D outputs are connected in parallel, we recommend using Channel A and Channel D outputs for consistency. In addition, the values of the speaker fuses should be cut in half. For example, if the manufacturer of your speaker recommends a 2 ampere fuse for its protection, each speaker fuse in the QSA-300 should be changed to 1 ampere.

THE MC-3 ACCESSORY METER OPTION KIT

The optional meter kit is most easily installed after step 18 on page 18 of these instructions, before continuing to step 19. The directions for installing the MC-3 kit will be found on the back of the Pictorial Diagram.

The action of the meters supplied is "fast" enough to respond to substantial musical peaks, but no meter can accurately indicate the magnitude of transient waveforms which occur in music. They are effective in determining electrical balance of quad programming, but the very nature of quad implies discrete information on each channel, so exact level matching rarely occurs. With sine wave test signals and an *accurate* 8 ohm load, the meter is a measure of output power. A square wave test signal puts out approximately 11% more voltage than the equivalent sine wave meter indication.

To protect the meters from "pegging" (overdrive), it is recommended that the 0 dB position of the meter range push button switches be used where the anticipated power levels are not known, and when starting any test. Switching to successively higher sensitivity ranges until the loudest passages indicate near "0" will yield the most information.

The accompanying chart lists 8 ohm load power outputs in watts for each meter range. For a 4 ohm load, the wattage should be doubled. For a 16 ohm load, the wattage should be halved. When the amplifier is wired for stereo use both meters on each side will indicate the output of each channel, and the power indicated remains the same as the chart below.

SCALE	METER RANGE			
	0 dB	-6 dB	-12 dB	-18 dB
+ 3	150	37.5	9.4	2.4
0	75	18.75	4.7	1.2
- 3	37.5	9.4	2.4	0.5
-10	7.5	1.87	0.47	0.12

240 VOLTS AC LINE CONNECTIONS

The power transformers supplied in the QSA-300 may be connected for a 220-240 volts AC line, as well as for the standard 120 volts AC line (the transformers are wired for 120 volts use unless this manual and the outer shipping carton are marked "240 volt"). Each transformer has dual primary windings. They are connected in parallel for 120 volts, and in series for 240 volts. The notes to steps 29, 30, 31, and 32 on page 16 and to steps 8 and 9 on page 17, the sketch on page 13, and the schematic diagram on page 12 detail the 240 volts connections.

The 10 ampere slo-blo fuse supplied with 120 volts wiring should be replaced with a 5 ampere slo-blo fuse when it is wired for 240 volts use.

This amplifier may be used with either 50 or 60 Hz current.

IN CASE OF DIFFICULTY

If there is an initial fault with your component system, or one develops in use, separate units enable relatively easy diagnosis of the source of the problem. Before blaming the electronics, check the connections on all components, particularly carefully on the preamplifier. See that the connections agree with the instructions supplied for each component. Check on the preamplifier that the monitor switch is in its normal or "input" position. If the Dynaco PAT-5 is used, also see that the E.P.L. switch is in its normally "out" position.

If no channel works with any program source (phono, tuner and tape), it is unlikely that all sources would be faulty. To test whether the problem lies in the preamplifier, temporarily connect the audio cables from the tuner or tape deck to the inputs of the QSA-300. Use the volume control or level set on the tuner or deck to adjust volume. If the system operates without the preamplifier, even after double checking its connections, the preamplifier is at fault. If the system is still defective, check the *speaker* fuses on the back panel of the QSA-300 and the speaker connections at both ends. Also, if the amplifier's heat sinks are very warm, allow the unit to cool off and try again, for the thermal sensors may have shut down the amplifier. If the amplifier is cool, and if the connections and the speaker fuses are all right, the fault lies in the QSA-300.

A fault in only one channel suggests interchanging the audio cables channel for channel to determine the problem. If the fault occurs with only one sound source, such as phonograph, the problem cannot lie in the QSA-300. Interchange the phono cables at the preamplifier. If the fault reverses channels, the problem is in the source. Check the phono cables, the connection of the cartridge in its mounting shell, and the connecting pins between the shell and the tone arm.

If the fault lies in one channel with any sound source, check the cables between the preamplifier and the QSA-300, as well as the speaker wires and the speaker fuses. If these are not defective, connect the tuner or tape deck directly to the QSA-300. If the problem goes away, the fault is in the preamplifier. If the fault remains, interchange the speakers channel for channel. If the problem follows a given speaker, the speaker is faulty. If the problem remains in the same channel regardless of the location of the speakers, one channel of the QSA-300 is faulty.

Because 90% of the difficulties encountered with kit-built units can be attributed to incorrect wiring or poor solder connections, it is strongly recommended that you ask someone else to check your wiring against the Pictorial Diagram, for one person will frequently make the same error repeatedly.

There are certain general precautions to be observed when servicing any semiconductor equipment:

1. Never make circuit changes of any kind when the amplifier is turned on.
2. Be particularly careful not to short any transistor leads to each other or to the chassis when the power is on.
3. When using test equipment, you must avoid transient voltage peaks and excessive test voltages.
4. Exercise caution when soldering and unsoldering semiconductor leads to avoid excessive heat.

If circuit difficulties are encountered with the QSA-300, the average kit builder will not likely be able to locate the source of the problem. **DO NOT ATTEMPT TO SERVICE THIS AMPLIFIER UNLESS YOU HAVE THE KNOW-HOW AND SUITABLE TEST EQUIPMENT.**

CHECKING SEMICONDUCTORS

An ohmmeter can serve as a rough check for transistor or diode failure. The transistor must be removed from the circuit for this test. For the purposes of this test all transistors can be considered to be two diodes connected in series with common elements tied together. The junction point represents the base of the transistor.

With one ohmmeter probe connected to the base, the other probe should be connected to the collector and emitter in turn. Readings from the base to the collector, and from the base to the emitter should be similar. With one orientation of the probes, there should be a high resistance reading (almost an open circuit). When the polarity of the probes is reversed, there should be a relatively low reading. The high reading will appear with one orientation of the probes for a pnp transistor, and with the opposite orientation for an npn transistor. Then the ohmmeter should be connected from collector to emitter, and a high resistance should be read (almost open circuit), regardless of the orientation of the probes. If all these qualifications are met, the transistor does not exhibit any gross defects.

In similar fashion, diodes can be checked by verifying that they have a high resistance in one direction, and low resistance in the other.

TESTS

The availability of a VTVM, TVM, or VOM with at least 20,000 ohms per volt sensitivity will enable you to make some checks to minimize the likelihood of trouble. Since each PC-43 circuit board has been checked in actual operation prior to packing into the kit, a component fault there is not likely. However, a splash of solder, poor or wrong connections, or broken or shorting component leads can result in failure.

The following resistance reading should be made with the amplifier unplugged, and with all eight B+ fuses and the four speaker fuses removed from the circuit:

From the rear of the B+ and B- fuse clips to ground: over 4,000 ohms.

Large variations are possible because of differences in types of meters, and variations in output transistors.

If a reading is low, remove the two wires on PC-43 which correspond to the trouble source. (B+ for channels B or D is holes #2 and #3; B- for channels B or D is holes #10 and #11; B+ for channels A or C is holes #24 and #25; B- for channels A or C is holes #16 and #17). Check from these holes to ground, and the associated output transistor to determine which is causing the low reading. If the board is at fault, check for solder splashes, bad connections, or defective components. If the output stage is at fault, check for shorts between the transistor case or its pins and the heat sink, or for a defective transistor.

If the reading is very high, examine the circuit for open connections or an open transistor on the board or output stage.

NO SOUND OUTPUT

A blown fuse is the most likely cause of interrupted sound in one (or both) channels. First check the speaker fuses, then the power fuse, and finally the B+ fuses. A failed speaker fuse usually indicates that you have driven the system at a high enough level to "open" the fuse. Replacement should restore sound. However, the failure of either the power fuse or the B+ fuses usually indicates more than routine difficulty. When one of these fail, take B+ and B- resistance readings, as outlined above, to find the source of the trouble.

BIAS ADJUSTMENT

The output bias current has been set at the factory, and should remain in proper adjustment for the life of the amplifier. However, should you wish to check the output bias, the following procedure should be followed:

1. Remove the input connections, and also the load from the output connections.
2. Remove the B+ fuse (each outer fuse of the 4 clip fuse blocks) from the channel to be adjusted (you should not remove the B- fuse).
3. Connect the "+" lead of an ammeter to the front fuse clip, and the ground lead to the rear fuse clip. Avoid shorting out the leads or allowing them to make intermittent connections.
4. Turn the unit on, wait about 10 seconds, and adjust the B+ current (trimpot P102) for approximately 75 milliamps.
5. Leave the amplifier on for 10 minutes until operating temperatures have stabilized. With a volt meter connected to the output terminals, set the center line voltage (trimpot P101) for 0 volts (± 20 millivolts).
6. Once again check the B+ current. It should still be about 75 milliamps. If not, readjust to that value.

Repeat the procedure for the other channels. Since the amplifier's temperature will have been stabilized, wait only 2-5 minutes before adjusting the center line and finally rechecking the B+ current.

NOTE: The actual current through the output transistors is 25 milliamps less than the total B+ current through the output stage. By adjusting the B+ current for 75 milliamps, optimum bias of 50 milliamps is achieved.

VOLTAGES AND PC-43 BOARD LAYOUT

The chart below lists the voltages and the location of the test points. The values are based on a 120 volts, 60 Hz line, amplifier connected in quad, shorted input and no load connected to the output. All voltages are with respect to circuit ground (GL1, GL2). Tolerance: 20%.

VOLTAGE	PICTORIAL CIRCUIT LOCATION
37 v. AC	Diode Block lug #2, #4
48 v. AC	Terminal Strip T-3 lug #4, #5
+50 v. DC	Capacitor C-1 lug #2 B+ Fuse Block lug #1, #4, #5, #8
-50 v. DC	Capacitor C-2 lug #3 B+ Fuse Block lug #2, #3, #6, #7

NOTE: When measuring voltages, it is important to take volt meter accuracy into account. Most volt meters are specified for accuracy with respect to the range selected. This means, for example, that a voltage reading on $\pm 5\%$ meter could be off by ± 5 volts on the 100 volt range. In the QSA-300 this could imply an incorrect indication when measuring the DC supply, which has been specified ± 10 volts (with a 120 volt line). Even if the voltages were exactly 50 volts, a $\pm 5\%$ meter reading could indicate a voltage from 35 to 65 and still be within the specifications of both the meter tolerance and the voltage tolerance. It is therefore necessary to always consider the tolerance of *both* the voltage being measured and of the measuring instrument.

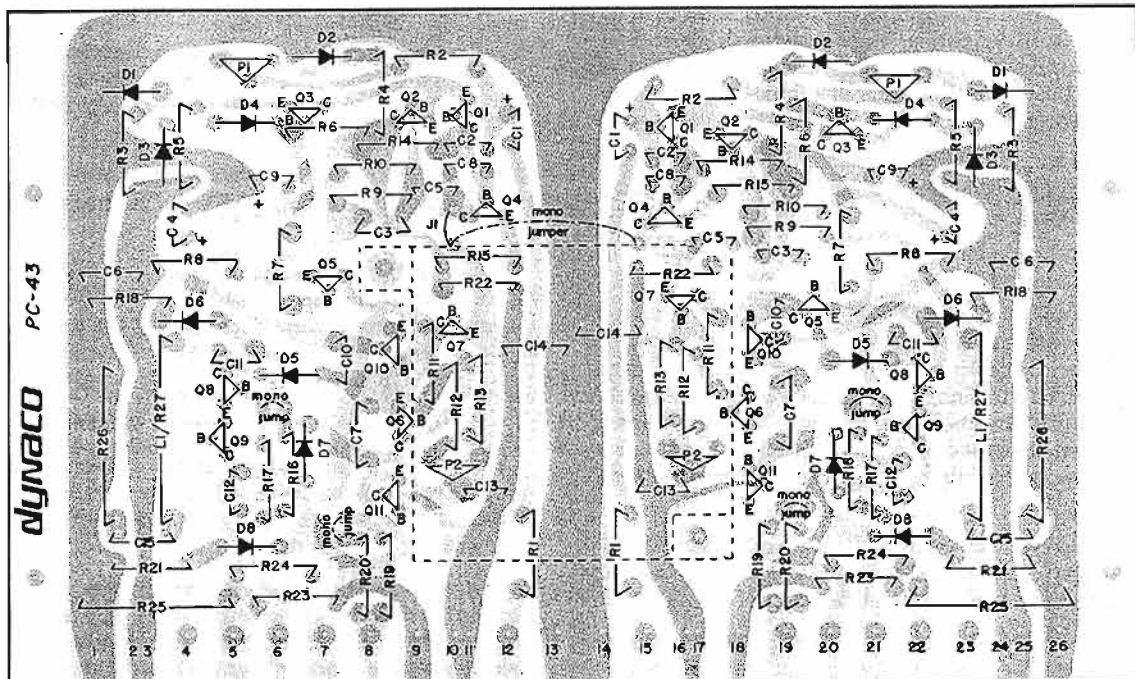
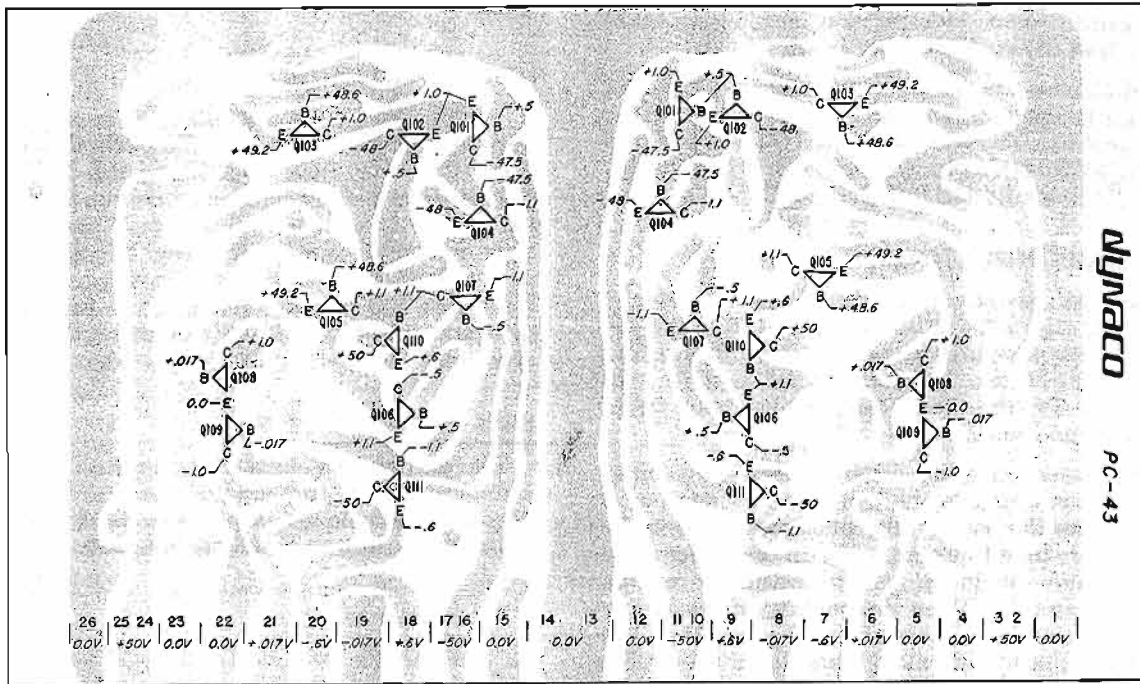

SERVICE POLICY AND LIMITED WARRANTY

The QSA-300 has been carefully engineered to provide many years of musical enjoyment without difficulty. Each factory-assembled QSA-300 has been subjected to a full complement of performance tests prior to shipment. Each PC-43 circuit board in the kit has been tested and adjusted in operation as a fully functioning unit to verify its performance capability. Nevertheless, through damage in transit, faulty kit assembly, or human error, service may sometimes be required.

To provide rapid and reliable service, Dynaco has authorized competent, well-equipped service facilities in several localities in the United States and Canada, in addition to its service facility at the factory. These stations are authorized to make repairs in and out of warranty under the terms listed below. Service is always available at the factory, but you will often find a more convenient facility locally. A current list of these facilities is enclosed. Write to Dynaco for the name of the service station nearest you.

It is the owner's responsibility to *take or send the unit freight prepaid to the service facility. A dated bill of sale must be submitted.* In the event that you incorrectly diagnose which unit is faulty, please understand that you will be responsible for a check-out charge on any properly performing kit or factory-assembled unit submitted for testing.

Shipment should be made via motor freight, REA Express (CN or CP Express in Canada), or Bus Package Express. **DO NOT USE PARCEL POST FOR IT IS NOT A SAFE METHOD OF SHIPPING ELECTRONIC EQUIPMENT.** Should damage occur due to unauthorized parcel post shipment of the complete amplifier, repairs will be made at the owner's expense, as neither the factory nor the service stations has the facilities to process parcel post claims. Be sure the shipment is fully insured (note Bus Express limitations).

When shipping the amplifier, use the original carton with all the styrofoam inserts. Include with the returned unit the following information:

1. Your name and complete shipping address (Post Office box numbers are not suitable);
2. The serial number (from the cover of this manual), *together with a copy of your dated bill of sale;*
3. The symptoms, complete, but preferably brief. If the problem is intermittent, this *must* be noted.

Once service work has been performed, an additional 90 day unconditional warranty is provided, including shipment both ways.

Warranties apply to the original purchaser only; they are not transferable. They do not apply to units which have been physically or electrically abused, or to units which have been modified without prior written factory authorization. The use of non-Dynaco replacement parts may in some instances void the warranty. If you suspect a defect in the power transformer, the leads must be unsoldered, not cut for its return. The warranty on the transformer is void if the leads have been cut too short for re-use.

Dynaco maintains a Technical Services Department to help you locate the source of, and possibly correct a problem yourself. When writing, mention the serial number of the QSA-300 and any tests you have performed.

WARRANTY FOR KIT-BUILT UNITS

The components in a QSA-300 kit are warranted for a full year from the purchase date. If a defective component is found in a completed circuit board module, or kit, simply return that individual part to the *factory* prepaid, and it will be replaced at no charge. Local service stations are not obligated to supply separate parts.

If you cannot locate the source of the difficulty, ship the entire QSA-300 to the nearest authorized service station or to the factory for service. A dated bill of sale must be submitted. In-warranty parts will be replaced at no charge, although a service fee will be charged for the labor to diagnose, correct, and test the unit to ensure that it meets factory specifications. Shipping charges to and from the service facility are the owner's responsibility. Units will be returned on a COD basis via motor freight wherever possible.

The return of a single circuit board for service to the factory or to an authorized service station is not adequate to assure proper operation, and a single circuit board submitted for repair will be returned unserviced.

This warranty is void if the kit has not been completely assembled, or if other than rosin core solder has been used. Units assembled with acid core solder or paste flux will be returned unserviced.

WARRANTY FOR FACTORY ASSEMBLED UNITS

The QSA-300A is warranted for a full year from the purchase date, including parts and labor, and shipment costs from the service facility to the owner (within the U.S. or Canada). The owner is responsible for shipment to the service facility, and must submit a copy of the dated bill of sale.

SERVICE BEYOND THE WARRANTY PERIOD

Dynaco establishes maximum labor fees which may be charged by its service facilities (plus the cost of parts, and shipping charges) without prior approval by the owner. A current list of authorized service stations, and the current established fee for any unit will be supplied by Dynaco on request. Dynaco cannot assume responsibility for service at other than *Dynaco authorized service stations.*

Dynaco reserves the right to limit the service facility or the established fees to two years from the date of purchase. Dynaco assumes no liability or responsibility for injury or damages sustained in the assembly or operation of this equipment, or for damages to other equipment connected to it. Dynaco reserves the right to make design changes without the obligation to revise prior versions. Prices and specifications subject to change without notice.

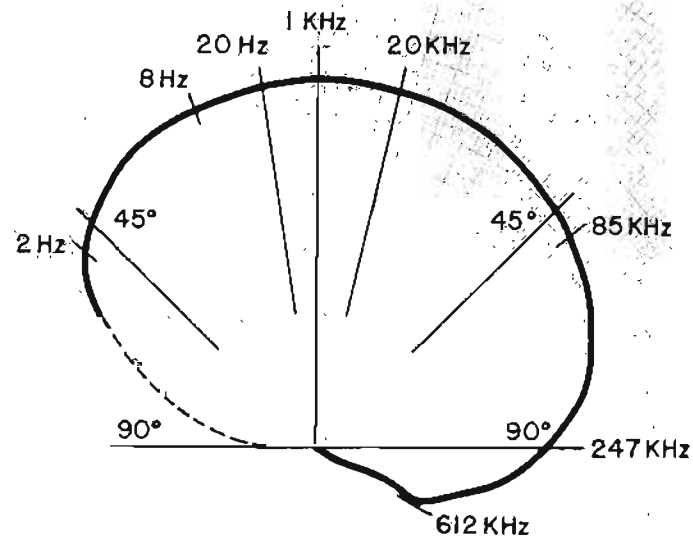

Gain-Phase Relationship

PARTS LIST

Parts of a similar type which do not change performance will sometimes be included as a matter of expediency. This will account for slight variations in value and appearance.

	PART #		PART #
1 Back Panel, black aluminum	711300	<i>Insulator Assembly</i>	997151
1 Chassis, plated steel	711039	2 Insulator, input socket strip	801372
1 Cover, black steel (for chassis)	711035	8 Insulator, grey metal, transistor	856001
4 Cover, black, perforated (for transistors)	711031	1 Lamp Insert, plastic sheet, blue	811003
1 Front Panel, plated steel	711301	1 Light Shield, gray fishpaper	871016
1 Front Plate, aluminum extrusion	769300	8 Fuse, 4 ampere, AGC/3AG	342004
1 Front Plate, insert, aluminum sheet	767011		
1 Front Plate, plastic panel	811005	<i>Diode-Resistor Assembly</i>	997152
1 Front Plate, fiber insert	875006	4 Capacitor, .1 μ f disc	224104
4 Heat Fin, black, aluminum	767006	4 Capacitor, .02 μ f disc	227203
1 Panel, wood, left side	867035	9 Diode, plastic, small	544012
1 Panel, wood, right side	867137	4 Fuse, 3 ampere, AGC/3AG	342003
		1 Fuse, 10 ampere, 3AB	342016
4 Binding Post with hardware, black	315001	2 Lamp, bayonet #53	526053
4 Binding Post with hardware, red	315002	8 Resistor, 0.33 ohms, 5 watts	120033
4 Bracket, Z-shape, audio circuit board	717016	4 Resistor, 0.27 ohms, 5 watts	120027
4 Bracket, round, capacitor	717003	4 Resistor, 10,000 ohms, 1 watt (brown-black-orange)	115103
4 Capacitor, 10,000 μ f	284109		
2 Circuit assembly, PC-43 board	957043	<i>Hardware Assembly</i>	997153
2 Diode Block, rectifier	544504	9 #4-40 x $\frac{3}{8}$ oval head machine screw	611265
4 Foot, rubber	859757	9 #4-40 KEP nut (lockwasher attached)	615244
4 Fuse Holder, round, with hardware	341001		
1 Fuse Holder, rectangular, single clip	341003	56 #6-32 x $\frac{1}{2}$ oval head machine screw	611385
2 Fuse Holder, block type, 4-clip	341010	2 #6-32 x $\frac{3}{4}$ oval head machine screw	611325
1 Label, caution	898013	10 #6-32 x $\frac{3}{8}$ flat head machine screw	611364
1 Label, serial number, kit	898011	6 #6-32 x $\frac{5}{8}$ Phillips head machine screw (black)	611306
1 Line Cord	322091	16 #6 x $\frac{3}{4}$ sheet metal screw (blunt tip)	612304
2 Socket, lamp	386001	28 #6 x $\frac{3}{8}$ Phillips head sheet metal screw (black)	612367
8 Socket, transistor	353001	10 #6 x $1\frac{1}{2}$ Dia. flat washer (black)	616363
2 Socket Strip, dual input	355012	68 #6-32 KEP nut (lockwasher attached)	615304
1 Switch, power, black rocker	334021		
5 Terminal Strip, 6 lugs, long	375010	4 #8 lockwasher	617405
2 Terminal Strip, 6 lugs, short	375016	8 #10-32 x $\frac{1}{2}$ oval head machine screw	611584
2 Thermal Breaker	342011	8 #10-32 x $\frac{3}{8}$ SEMS machine screw (lockwasher attached)	613564
1 Thermal Compound, capsule	945004	8 #10 x $\frac{7}{8}$ Dia. flat washer	616005
4 Transistor, 2N6030 or 2N6031	561357	10 #10 solder lug	639309
4 Transistor, 2N5630 or 2N5631	571105	8 #10-32 KEP nut (lockwasher attached)	615504
2 Transformer, power	464090		
1 Strain Relief, black plastic	895010	4 $\frac{1}{4}$ "-20 x $\frac{3}{4}$ oval head screw	611602
1 Wire, #20 hookup, black, 10 ft.			
1 Wire, #20 hookup, blue, 11 ft.			
1 Wire, #20 hookup, yellow, 12 ft.			
1 Wire, #16 hookup, white, 14 ft.			
1 Warranty Card			
1 Instruction Manual			

TYPICAL PERFORMANCE CURVES

To arrive at "typical" curves, four channels were evaluated on all bases. In each case, the curve shown is the next-to-the-worst of the four. Therefore, do not expect exact correlation between curves.

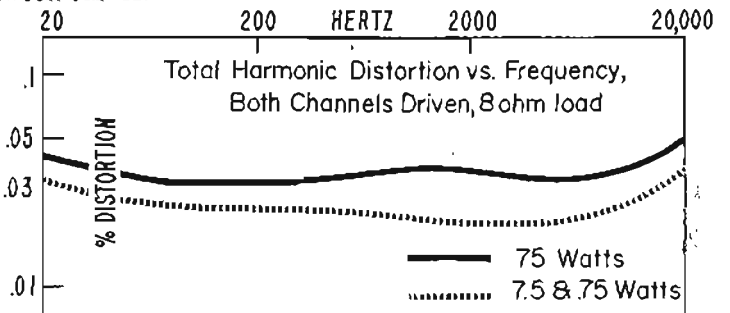
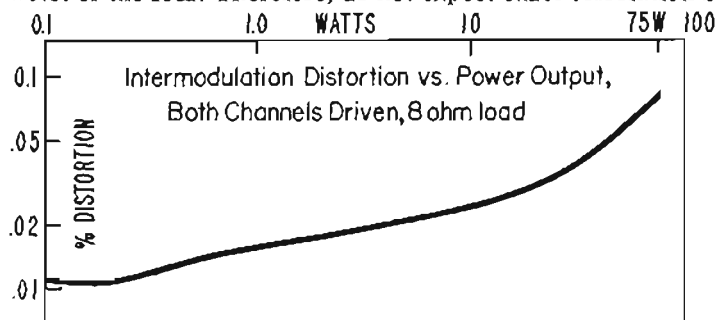

ACCESSORY MC-3 METER KIT

DISASSEMBLY OF A FULLY ASSEMBLED QSA-300

Skip this section if you are building the amplifier kit, and have now completed step 18 on page 18 of the kit manual.

- 1() Remove the wood panel on each side of the unit. There are three black #6 Phillips head screws and flat washers which affix each panel to a side.
- 2() Remove the cover from the amplifier. There are 14 black Phillips head sheet metal screws holding it in place.
- 3() Slide out the dark plastic decorative strip and its mating black fiber insert from the top section of the front plate. Discard the fiber insert.
- 4() Remove the front plate from the front panel. There are six flat head screws and nuts holding it in place. Discard *three* of the screws and nuts.
- 5() Peel off and discard the self-adhesive decorative aluminum strip from the bottom of the front plate, and along with it the small piece of blue plastic. A thin knife or single-edge razor blade slipped between the decorative strip and the front plate will aid in its removal.
- 6() Turn the amplifier upside down, and remove the three Phillips head sheet metal screws which affix the front panel to the bottom of the chassis. Also loosen, but do not remove, a screw in the corner hole of the front panel at each end.
- 7() Turn the unit right side up. Remove and discard the cardboard light shield. Remove the two lamp sockets from the front panel, and also the diode between them. A flat head screw, a lockwasher, and a nut hold each to the panel. Next, unsolder the black wire of the twisted pair of wires from the sockets on the *right* side terminal strip T-3 lug #2 at the tip. Also unsolder the yellow wire from the twisted pair on the right side diode block lug #2. Discard all the parts, except for the #53 lamps (which may be kept as spares).

ASSEMBLING THE MC-3 KIT

Begin here if you are continuing from step 18, page 18 of the QSA-300 manual.

- 1() Select the long metal lamp housing, the eight lamp sockets, the eight #6 x $\frac{3}{16}$ screws (largest screws but shortest length), and eight #6 KEF nuts (lockwashers attached). Position the housing so that the outer flanges face you. Insert the screws from underneath (outside), install each lamp socket over the screws on the inside, and fasten with a nut on the inside. Position the sockets on the angle shown, and tighten the screws firmly.
- 2() Prepare four $3\frac{1}{2}$ " (9 cm) black wires, by removing $\frac{1}{4}$ " (.6 cm) of insulation from their ends. Connect one end of the first wire to lamp socket lug #15 (S), and the other end of this wire to socket lug #14 (S). Connect one end of the second wire to socket lug #11 (S), and the other end to lug #10 (S). Connect one end of the third wire to lug #7 (S), and the other end to lug #6 (S). Connect one end of the fourth wire to lug #3 (S), and the other end to lug #2 (S). Position each wire against the lamp housing.

- 3() Strip the insulation from a 3" (7.5 cm) black wire, and cut the bare wire into three equal pieces. Connect one end of the first bare wire to socket lug #13 (S), and the other end to lug #12 (S). Connect one end of the second bare wire to socket lug #9 (do not solder), and the other end to lug #8 (S). Connect one end of the third bare wire to socket lug #5 (S), and the other end to lug #4 (S).
- 4() Prepare a 4" (10 cm) black wire. Connect one end to socket lug #9 (S-2). Position this wire as shown. The other end will be connected later.
- 5() Prepare an $11\frac{3}{4}$ " (30 cm) blue wire. Connect one end to socket lug #16 (S). Position this wire as shown. The other end will be connected later.
- 6() Prepare a $12\frac{1}{2}$ " (32 cm) yellow wire. Connect one end to socket lug #1 (S). Position this wire as shown. The other end will be connected later.
- 7() Select the eight #53 lamps, and install them in the lamp sockets. They merely push in and turn.

Set this assembly aside, and place the QSA-300 in front of you, front panel toward you. Tilt the front panel forward so that its top edge touches the work surface.

- 8() Select the four meters, and fit them from the inside so that the cross-slotted adjustment knob engages a mating hole near the top of the front panel.
- 9() Select the lamp housing, and the two $\frac{3}{4}$ " #6 screws and KEF nuts. Invert the housing over the meters, so that its flanges stay inside the front panel lip. Install the screws from the front (underneath) in the center left and center right holes between meters "A" and "B", and between meters "C" and "D". Install the nuts but do not tighten them beyond that necessary to keep the meters snug—they should not rattle.
- 10() If "U" shaped wires connect the terminals on each meter, remove them.
- 11() Select the eight solder lugs, and the eight #10 nuts (without attached lockwashers). Install a solder lug on each meter terminal, position the lugs as shown, and secure each with a nut.
- 12() Select the black wire from the lamp housing, and connect the free end to solder lug #4.
- 13() Select the blue wire from the lamp housing, and connect the free end to the *left* T-3 lug #5 at the tip (S-2). A red transformer lead also connects here.
- 14() Select the yellow wire from the lamp housing, and connect the free end to the *right* T-3 lug #5 at the tip (S-2). A red transformer lead also connects here.
- 15() Prepare three 5" (12.5 cm) black wires. Connect one end of the first wire to solder lug #8 (S), and connect the other end of this wire to lug #6. Connect one end of the second wire to lug #6 (S-2), and the other end to lug #4. Connect one end of the third wire to lug #4 (S-3), and the other end to lug #2.
- 16() Prepare a $12\frac{1}{2}$ " (32 cm) black wire. Connect one end to solder lug #2 (S-2). Connect the other end to the *right* T-3 lug #2 at the tip (S-2). A red-yellow transformer lead also connects here.

WIRING PC-38

You will now install the parts on circuit board PC-38. All the resistors and diodes should be installed against the circuit board on the side which carries the identifying markings. Solder each lead to the back (circuit) side, and cut off all excess leads close to the board.

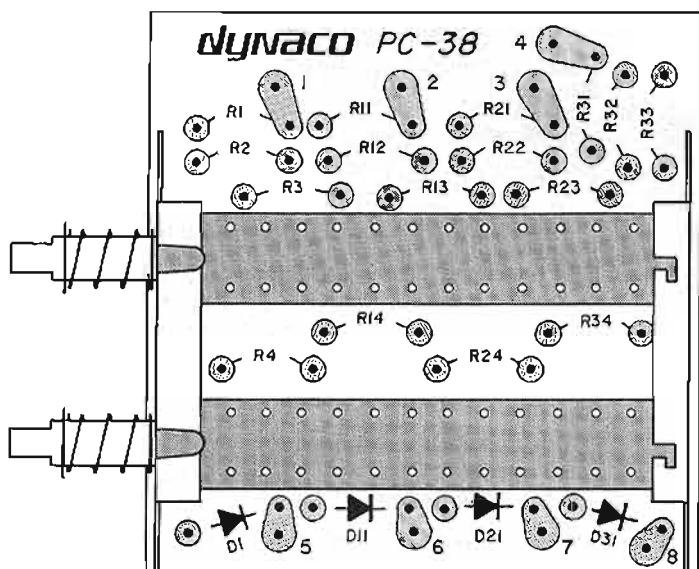

- 1() Select the PC-38 circuit board, and the four 1200 ohm, $\frac{1}{4}$ watt resistors (*brown-red-red*). Solder these in locations R1, R11, R21, and R31.
- 2() Select the four 2000 ohm, $\frac{1}{4}$ watt resistors (*red-black-red*), and solder them in locations R2, R12, R22, and R32.
- 3() Select the four 3900 ohm, $\frac{1}{4}$ watt resistors (*orange-white-red*), and solder them in locations R3, R13, R23, and R33.
- 4() Select the four 7500 ohm, $\frac{1}{4}$ watt resistors (*violet-green-red*), and solder them in locations R4, R14, R24, and R34.

The diodes supplied have their cathode end marked with a stripe, an arrow head, or a colored tip. It is this *marked* edge that will be referred to in the next step.

- 5() Select the four diodes, part #543541 (1N541), and install them in locations D1, D11, D21, and D31. The arrow head on the board points toward the marked end of the diode. Solder securely.
- 6() Select the push button switch and install it on the board, positioned as shown in the accompanying sketch. *Do not place the switch flush against the board, but allow the pins to barely protrude through the back so that the switch is supported about $\frac{1}{8}$ " (.3 cm) above the board.* Solder all 48 pins on the back of the board.

This completes the installation of the parts to the PC-38 board. Now is the time to check all your connections. No solder blobs or excess wire should connect other than the intended hole. Cut off any excess wire on the back of the board with your side cutters. Observe that all holes numbered 1 through 8 are as yet unconnected.

FINAL ASSEMBLY

- 1() Select the PC-38 assembly, the two $\frac{3}{4}$ " #4 flat head screws and $\frac{1}{2}$ " spacers. Insert the screws from the outside through the two countersunk holes adjacent to the small front panel cutout. Slip the spacers over the screws on the inside, carefully install the switch assembly so that the components face up, and fasten with the $\frac{1}{2}$ " spacers. Securely tighten the hardware.
- 2() Prepare an 8" (20.5 cm) blue wire. Connect one end to meter solder lug #1 (S). Connect the other end to PC-38 hole #5 (S). You may solder this wire, and the wires to the other holes on PC-38, to either side of the board.
- 3() Prepare a 12" (30.5 cm) yellow wire. Connect one end to solder lug #3 (S). Connect the other end to PC-38 hole #6 (S).
- 4() Prepare a 16" (41 cm) blue wire. Connect one end to solder lug #5 (S). Connect the other end to hole #7 (S).
- 5() Remove the three black sheet metal screws under the back panel so that it may be tilted out.
- 6() Prepare a 21" (53 cm) yellow wire. Connect one end to solder lug #7 (S). Twist this wire several times around the other black, yellow and blue wires connected to the solder lugs, as shown in the sketch, so that they are neatly bundled together. Connect the free end to PC-38 hole #8 (S).
- 7() Prepare a 14" (35.5 cm) blue wire. Connect one end to the *right* red binding post lug #4 on the back panel (S-3), as viewed in the Pictorial Diagram for the QSA-300 kit. Position the wire along the right edge of the chassis, and connect the other end to PO hole #1 (S).
- 8() Prepare a 16 $\frac{1}{2}$ " (42 cm) black wire. Similarly connect one end to the right red binding post lug #1 (S-3). Position this wire next to the wire from the previous step, and connect the other end to PC-38 hole #2 (S).
- 9() Prepare a 22 $\frac{1}{2}$ " (57 cm) yellow wire. Connect one end to the *left* red binding post lug #4 (S-3). Position this wire along the bottom of the chassis to the right edge, and then next to the other wires from the previous steps. Connect the other end to PC-38 hole #3 (S).
- 10() Prepare a 26" (66 cm) black wire. Similarly connect one end to the left red binding post lug #1 (S-3). Position this wire along the bottom of the chassis to the right edge, and then twist this wire around the other three wires from the previous steps so that they are neatly bundled together. Connect the other end to PC-38 hole #4 (S).
- 11() Turn the amplifier on end, and install three each black sheet metal screws which affix the front panel and the back panel to the chassis. Tighten the screw in each corner hole. Also check to make sure that the circuitry of PC-38 does not contact the adjacent transformer hardware. Additional clearance may be obtained by sliding the transformer toward the center.

The wiring of the MC-3 is now complete. If you are building the QSA-300 kit, return now to the paragraph after step 19 on page 18 of the kit manual, and skip the following reassembly.

REASSEMBLY OF A FULLY ASSEMBLED QSA-300

- 1() Select the front plate, and the self-adhesive decorative strip supplied with this kit. Peel off the backing from the strip. Using the switch cutouts as a guide, affix the strip to the plate. Since the strip cannot be moved once it is installed, you may wish to first try a "dry run" with the backing in place prior to final installation.
- 2() Install the front plate on the front panel by securing it with three each #6 short and long *flat head* screws and *KEP* nuts. The long screws fit through the counter-sunk holes along the top edge and through the lamp housing; the short screws fit below the lamp housing. Install the nuts on the inside, but do not tighten them beyond that necessary to keep the meters snug.
- 3() Select the two black buttons. Notice that the shafts on the meter range switch are slightly offset toward the bottom of the opening. The buttons are similarly offset, and therefore they fit easily with only one orientation. Since the buttons are difficult to remove once they have been installed, make *certain* they are correctly positioned in the opening before pushing them home.
- 4() Combine the dark plastic decorative strip with the black fiber insert supplied with this kit, and install them in the top section of the front plate. They slide in place from either end. You may wipe the plastic strip and meter faces clean with a *damp* cloth and allow to air dry.
- 5() Slide on the cover, and secure it with fourteen black Phillips head sheet metal screws—7 screws at the front and 7 at the back. CAUTION: Sheet metal screws are *not* used between the cover and the chassis.
- 6() Install the two wood panels on the sides of the unit. The cutout section in the wood faces front, and notice that one panel is drilled for the left side, and the other for the right. Use the six $\frac{5}{8}$ " black Phillips head screws and flat black washers.

MC-3 PARTS LIST

Parts of a similar type which do not change performance will sometimes be included as a matter of expediency. This will account for slight variations in value and appearance.

	PART #
2 Button, rectangular	814052
1 Front Plate, insert aluminum sheet	767012
1 Front Plate, fiber insert	875007
1 Housing, meter lamp	711033
8 Lamp, bayonet #53	526053
4 Meter	508029
8 Socket, lamp	386001
1 Switch, 2 section push button	338003
1 Wire, #20 black, 9 ft.	
1 Wire, #20 yellow, 7 ft.	
1 Wire, #20 blue, 5 ft.	
1 Instructions	929044

PC-38 Assembly

	997154
1 PC-38 board, bare	950038
4 Diode, germanium, 1N541	543541
4 Resistor, 1,200 ohms, $\frac{1}{4}$ watt, 5%	119122
4 Resistor, 2,000 ohms, $\frac{1}{4}$ watt, 5%	119202
4 Resistor, 3,900 ohms, $\frac{1}{4}$ watt, 5%	119392
4 Resistor, 7,500 ohms, $\frac{1}{4}$ watt, 5%	119752

Hardware Assembly

	997155
2 #4-40 x $\frac{3}{4}$ flat head machine screw	611294
2 #4-40 <i>KEP</i> nut (lockwasher attached)	615244
8 #6-32 x $\frac{5}{16}$ oval head machine screw	611355
2 #6-32 x $\frac{3}{4}$ oval head machine screw	611325
3 #6-32 x $\frac{3}{4}$ flat head machine screw	611366
13 #6-32 <i>KEP</i> nut (lockwasher attached)	615304
8 #10 solder lug	639309
8 #10-32 nut	615564
2 Spacer, brass	660021

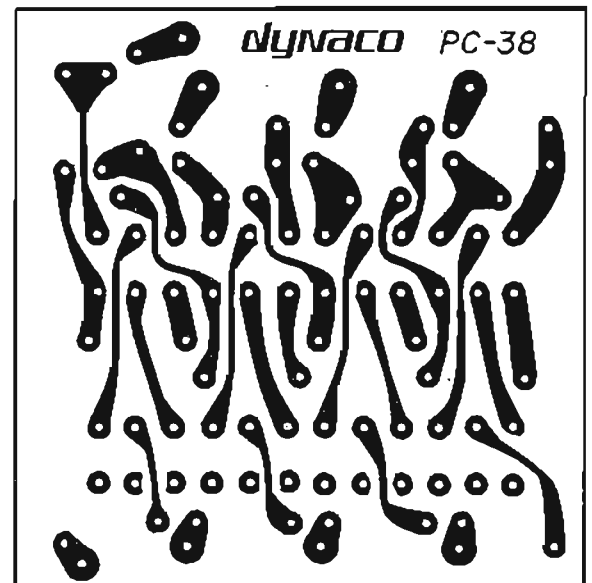
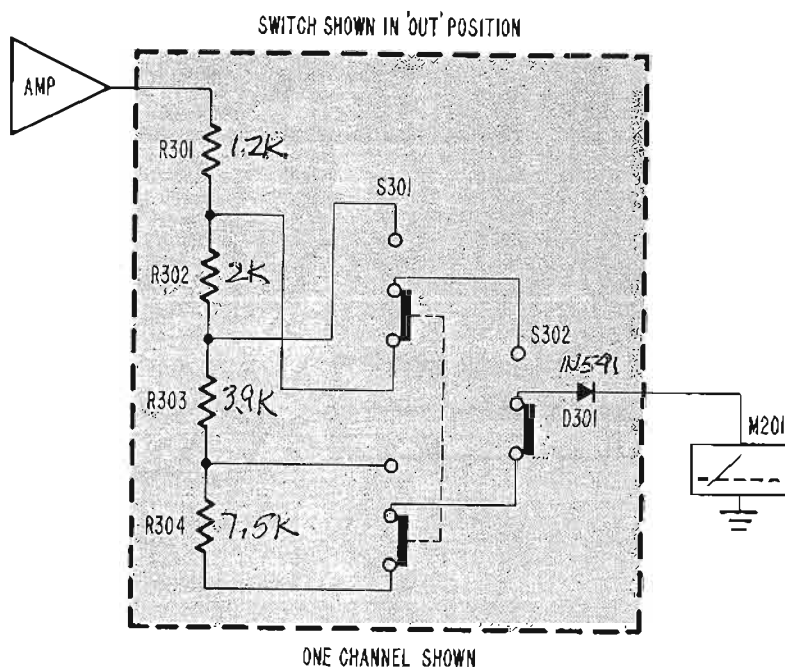

929044